

CAGES, LIDS AND ACCESSORIES FOR SMALL ANIMAL RODENTS





CAGES

FROM PLASTIC

Maximum number of animals per cage

Cage Type Floor Space Height	1 L 405 cm ² 14 cm	2 360 cm ² 14 cm	2 L 530 cm ² 14 cm	3 830 cm ² 15 cm	4 1.815 cm ² 20 cm
Mice					
< 20 g	7	6	8	13	30
20 – 25 g	6	5	7	11	26
25 – 30 g	5	4	6	10	22
> 30 g	4	3	5	8	18
Hamsters					
< 60 g	-	-	-	5	12
60 – 100 g	-	-	-	4	9
> 100 g	-	-	-	3	7
Rats					
< 200 g	-	-	-	-	9
200 – 300 g	-	-	-	-	7
300 – 400 g	-	-	-	-	5
400 – 600 g	-	-	-	-	4
> 600 g	-	-	-	-	3
Guinea pigs*					
< 200 g	-	-	-	-	9
200 – 300 g	-	-	-	-	5
300 – 450 g	-	-	-	-	4

Subject to technical modifications.

* In connection with lid DST 4/50 MS 5023424

For guinea pigs over 450 g we recommend our special guinea pig cage MKZ 80/25.

CAGES

FROM PLASTIC



Cage Type	Material	Dimensions (L x W x H) in mm	Floor space (cm ²)	Order No.
1 L	Polycarbonate	362 x 160 x 143	405	3010030
2 L	Polycarbonate	365 x 205 x 140	530	3010034
2 L	Polysulfone	365 x 205 x 140	530	3010041
3*	Polycarbonate	425 x 265 x 150	830	3010003
3*	Polysulfone	425 x 265 x 150	830	3010048

Subject to technical modifications.

* Minimum order quantity 250 pcs.

Other cages not shown with minimum quantities on request.

INSERT FLOOR

CAGE FLOOR



Type	For cage type	Mesh Width	Order no.
EB 1 L/30	1 L	MW 10 x 30, 20 mm height	5013040
EB 2 L/30	2 L	MW 10 x 30, 20 mm height	5013056
EB 3/30	3	MW 10 x 30, 20 mm height	5013043
EB 4/20	4	MW 10 x 30, 20 mm height	5013044



LIDS

MADE OF STAINLESS STEEL

ZOONLAB lids are made of stainless steel 1.4301 / AISI 304 and are electrolytically polished after processing. The type and shape of the feed rack is ground breaking. The wire clearance of the lid is 7 mm. The lids are available with a swing clip lock or frame clamp or as an internal cover for use with filter top. Furthermore, the feed racks can optionally be provided with a removable, detachable divider or with integrated hinged divider.

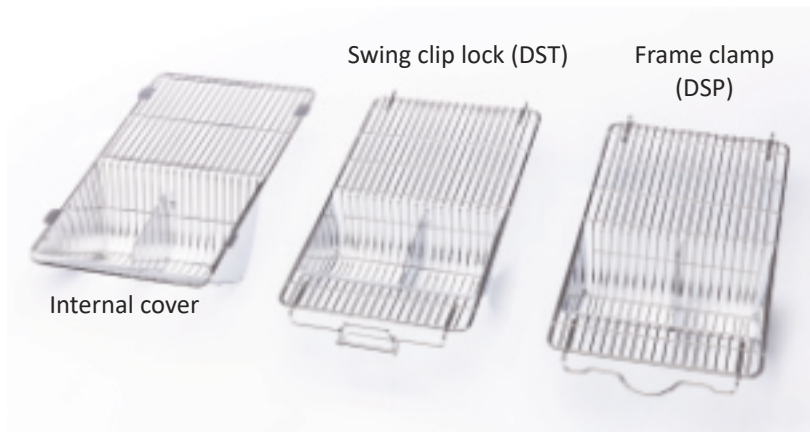

LID FOR CAGES TYPE 1 L



The lid has a wire frame on the outside that fits over the edge of the cage tray. This ensures that the lid is held securely in place on the cage tray. The lid is not suitable for use with a conventional filter hood.

Type	Order no.
DST 1 L	5023429

LIDS FOR CAGES TYP 2

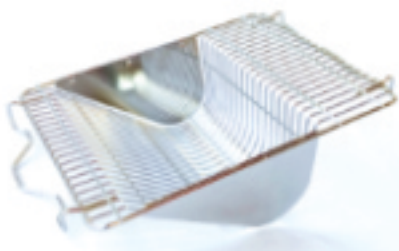

without integrated hinged divider

Frame clamp

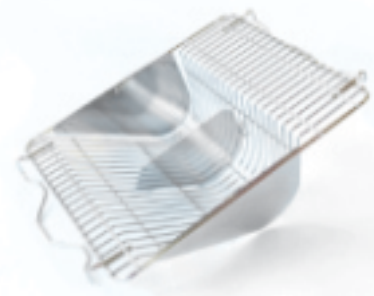

with integrated hinged divider

Type		Order no.
DSP 2 F	without integrated hinged divider	5023652
DSP 2 F iTB	with integrated hinged divider	5023656

LIDS

MADE OF STAINLESS STEEL

LIDS FOR CAGES TYPE 2 L



Wire frame outside

The lid has a wire frame on the outside that fits over the edge of the cage tray. This ensures that the lid is held securely in place on the cage tray. The lid is not suitable for use with a conventional filter hood.

Type	Order no.
DST 2 L BS	5023442



Swing clip lock, with integrated divider

Type		Order no.
DST 2 L F	w/o integrated divider	5023462
DST 2 L F iTB	with integrated divider	5023459



Frame clamp, with integrated divider

Type		Order no.
DSP 2 L F	w/o integrated divider	5023651
DSP 2 L F iTB	with integrated divider	5023658

LIDS FOR IVC FILTER HOODS CAGES TYPE 2 L

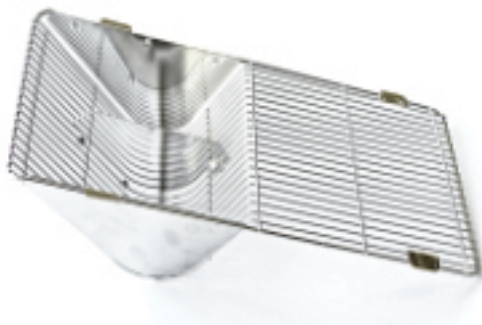

Type		Order no.
DST 2 L F eO	with integrated divider	5023481-2



LIDS

MADE OF STAINLESS STEEL

LIDS FOR CAGES TYPE 3



Wire frame outside

The lid has a wire frame on the outside that fits over the edge of the cage tray. This ensures that the lid is held securely in place on the cage tray. The lid is not suitable for use with a conventional filter hood.

Type	Order no.
DST 3 BS	5023413

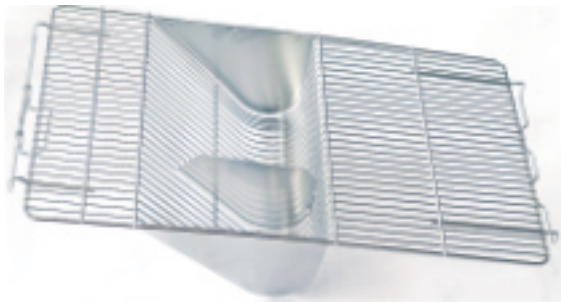

Swing clip lock, with integrated divider

Type	Order no.
DST 3 F iTB	5023455

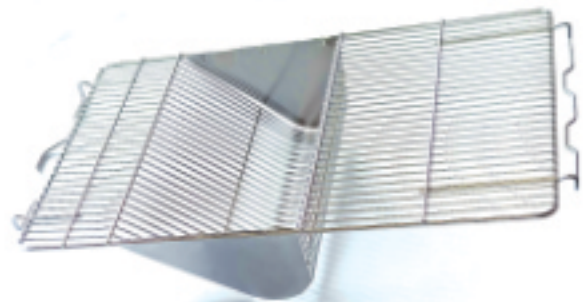

Frame clamp, without integrated divider

Type	Order no.
DSP 3 F	5023653

LIDS FOR IVC FILTER HOODS FOR CAGES TYPE 3



with integrated divider

Type	Order no.
DST 3 F2eOF	5023483

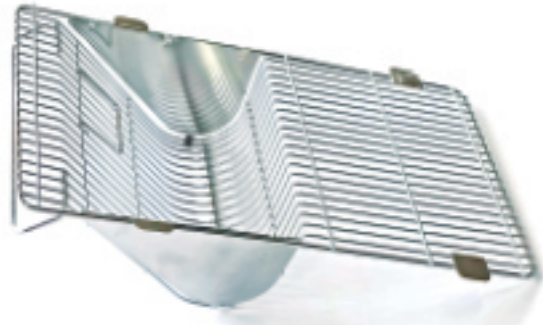

Type		Order no.
DST 3 FeO	w/o integrated divider	5023440
DST 3 FeOiTB	with integrated divider	5023453

LIDS

MADE OF STAINLESS STEEL

RAISED LID TYPE 3



The raised lids are particularly suitable for conventional rat housing. They offer the animals sufficient space for stretching and climbing.

Type	Order no.
DST 3-50	5023107

LIDS FOR CAGES TYPE 4 L

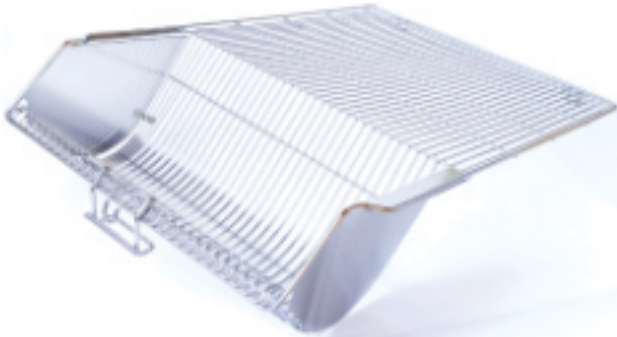

Swing clip lock

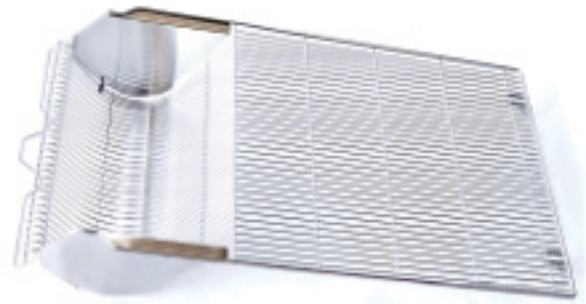

Frame clamp

Type	Order no.
DST 4 BS	5023414

Type	Order no.
DST 4 BS	5023614

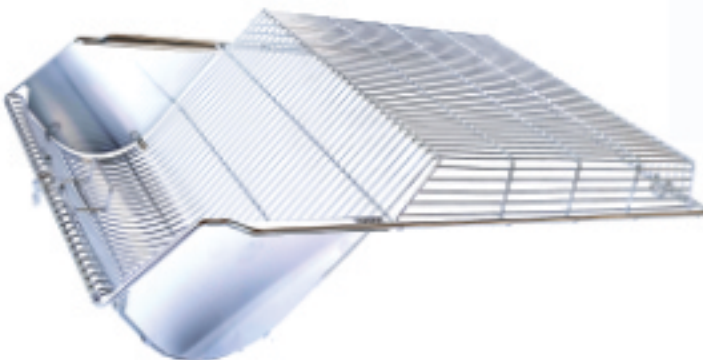

The raised lids are particularly suitable for conventional rat housing. They offer the animals sufficient space for stretching and climbing.

Type	Order no.
DST 4/50	5023105



DIVIDER

OPTIONALLY AVAILABLE, MADE OF STAINLESS STEEL

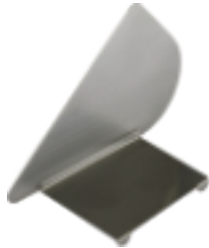

In order to divide the feed rack between the food and the bottle

For cages type	Brief description	Order no.
1 L	TB 1- BS	5023401
2 / 2 L	TB 2- BS	5023402
3	TB 3- BS	5023403
4	TB 4- BS	5023404

Subject to technical modifications.

FILTER TOP

FOR CONVENTIONAL HOUSING

Filter tops give the animals added protection. They are made of polycarbonate and are equipped with an exchangeable filter pad. Ideal for transporting caged animals.



FIH 2 L-MB filter top



Type 2 L cage, complete with filter top

For cages type	Brief description	PC Polycarbonate	Replacement filter pad (100 pieces)
2 L	FIH 2-L-MB	5010912S	3010913

Subject to technical modifications.

ADDITIONAL ACCESSORIES

FEED CONTAINER FOR FLOUR



FUR 5

FUR 2

Type	Capacity	Order no.
FUR 5	0,24 kg	5083705
FUR 2	0,14 kg	5083702

HOLE PUNCH



Made of stainless steel, autoclavable

Type	Description	Order no.
292-2	Hole for 2 mm ø	3104605

ZOONLAB offers a resharpening service with needle replacement if the punching pliers have become blunt. Please feel free to contact us.

EUTHANASIA COVER



Description	Order no.
Euthanasia cover for cages type 2 L	5023304
Euthanasia cover for cages type 3	5023309

CARD HOLDERS

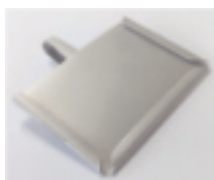

5104507

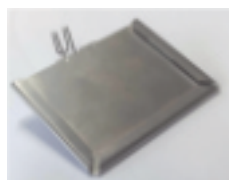

5104529

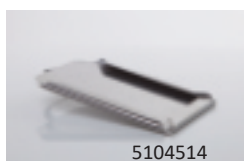

5104514



5104513S

Description	Order no.
For cages	1 L, 2 L, 3 L
Landscape for DIN A7 cards, made of stainless steel, with wire hanger for filter tops	5104507
Landscape for DIN A7 cards, made of stainless steel, foldable	5104529
Portrait for DIN A7 cards, made of stainless steel	5104514
Portrait for DIN A7 cards, made of poly-sulfone with stainless steel wire hanger	5104513S



WATER BOTTLES

FOR USAGE WITH SEALING RING

The F 30 and F 75 water bottles were manufactured for the first time 45 years ago and despite remaining unchanged, are still supplied today in a superior quality. These shapes have influenced the entire market. ZOONLAB water bottles are available with a silicone sealing ring. The water bottles are made of polycarbonate autoclavable to max. 121°C and of polysulfone, autoclavable to max. 134°C.

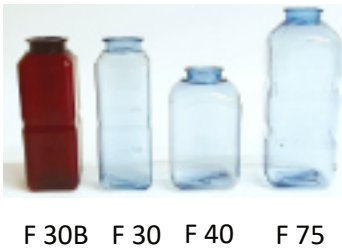

F 30B F 30 F 40 F 75

Type	Volume in ml	Dimensions in mm (W x D x H)	Polycarbonate Order no.	Polysulfone Order no.
Bottles with groove for silicone sealing ring				
F 30B (brown bottles)	300	53 x 53 x 150	3125012	-
F 30	300	53 x 53 x 150	-	3125028
F 40	400	72 x 72 x 120	3125005	On request
F 75	720	72 x 72 x 180	3125004	On request

ACCESSORIES FOR WATER BOTTLES

SILICONE SEALING RING

The silicone sealing rings, whether grooved or rubberised, guarantee that the bottle complete with cap remains water-tight.



SDR 3 blue

SDR 1



Typ	Material	Bestell-Nr.
SDR 1	Silicone, full rubber	3125101
SDR 3 / blue	Silicone, grooved	3125116

ACCESSORIES TO WATER BOTTLES

BOTTLE OPENER

Our stainless steel bottle opener makes it easy for you to remove the cap from the water bottle.



Bottle opener Ö 1

Type	Material	Order no.
Ö 1	Stainless steel	5122001



BOTTLE CAPS

The bottle caps are made of stainless steel (AISI 304) and electropolished. In order to remove the bottle caps, we recommend using our proven bottle opener.



Typ	Borehole mm	Tube length	Order no.
TR 25	1,8	25 mm tube, electropolished	3125045
TR 40	1,8	40 mm tube, electropolished	3125032
TR 50	1,8	50 mm tube, electropolished	3125049
TK 40		40 mm tube with ball closure, electropolished	3125042
TK 100		100 mm tube with ball closure, electropolished	3125052
TGK 100		100 mm curved tube with ball closure, electropolished	3125071
TGK 140		140 mm curved tube with ball closure, electropolished	3125072

MOUSE AND RAT ARCHES

ENRICHMENT MADE OF STAINLESS STEEL

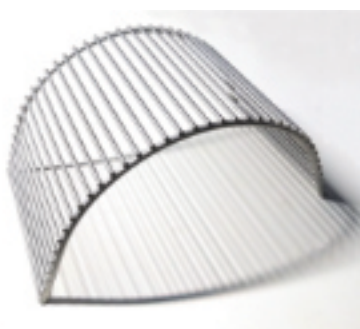

Mouse arch

Enrichment in the cage enriches the animal's environment and reduces stress and aggression. An increasing must for animal welfare. In addition to plastic enrichment, ZOONLAB also offers stainless steel solutions.

Do not hesitate to contact us.

Type	Dimensions (L x W x H) in mm	Order no.
small	142 x 90 x 60	5083804
medium	160 x 95 x 70	5083801
large	166 x 90 x 94	5083805

For more information see chapter 3 Enrichment



BOTTLE WASHING BASKETS

MADE OF STAINLESS STEEL, STACKABLE

ZOONLAB bottle washing baskets enable more effective and easier cleaning of all conventional-sized water bottles. They are made of stainless steel, electropolished and autoclavable. All of the washing baskets versions can be stacked on top of one another. The bottles are fixed into place via a detachable cover which also ensures that they remain secure during the cleaning process.

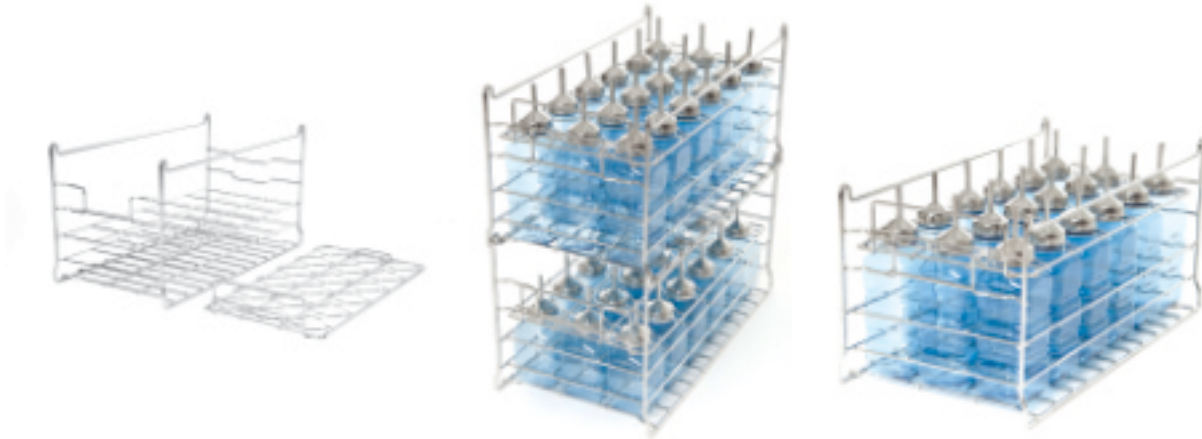

Type	No. of bottles / bottles types	Dimensions (W x D x H) in mm	Order no.
FSPÜ 25-30 / 250	18 / F 25 und F 30	500 x 265 x 250	5122099
FSPÜ 40-75 / 250	18 / F 53, F 40, F 75	500 x 265 x 250	5122100
FSPÜ 25-30 / 270	18 / F 25 und F 30	500 x 265 x 270	5122096
FSPÜ 40-75 / 270	18 / F 53, F 40, F 75	500 x 265 x 270	5122097
OPTIONS			
FSPÜ Cover	Suitable for FSPÜ 25-30 and FSPÜ 40-75	483 x 240 Handle 70 mm high	5122098



Type	Outer dimensions (W x D x H) in mm	Order no.
Washing baskets for small accessories		
SPÜ-Zub-small	Basket 520 x 265 x 160 Basket and lock 545 x 265 x 160	5122055
SPÜ-Zub 2	Basket 490 x 490 x 225 Basket and lock 495 x 500 x 225 Basket, lock and stacking wire 508 x 500 x 225	5122018

VARIABLE RACK GV

FOR CAGES, STOCKS AND MUCH MORE



In addition to the traditional types of racks, ZOONLAB also supplies a variable rack that can accommodate any type of cage.

It is characterised by 6 extremely stable shelves made of grid elements (the grid bars run in the sliding direction of the cage), which are also infinitely adjustable in height as required. This gives maximum freedom of use. The shelves can be loaded up to 250 kg.

The entire rack is made of AISI 304 stainless steel and is fitted with 4 swivel castors of 100 mm diameter, two of them have brakes. The castor housing is made of stainless steel. The rack and castors are fully autoclavable. A bowl holder can be added to the rack as an option.

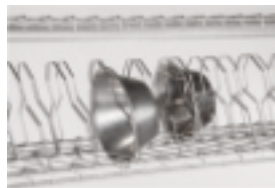

Bowl holder
Further options on request

For further transport systems see chapter 5

Short description	Capacity per shelf	Dimensions in mm (W x D x H)	Order no.
GV - Rack for variable mounting of the cages (depth 582 mm)	6 cages Type 1 L 5 cages Type 2 (10 cages Typ 2 double-sided placement) 5 cages Type 2 L 4 cages Type 3 3 cages Type 4	1.236 x 582 x 1.763	5033520
Optional components			
GV-Holder for feeding bowls			5063398
Cover plate with elevation			5033551
Additional shelf made of grid elements	Loadable with 250 kg - Screwable - Retrofit module		4033200
Additional upper part with cover plate	screwable - retrofitting module	H 250	5033222
GV - Rack for variable mounting of the cages, including cover plate with elevation (depth 832 mm)		1.236 x 832 x 2.013	5033533
Optional components			
Additional shelf made of grid elements	Loadable with 250 kg - Screwable - Retrofit module		On request



LECTERN

DOCUMENTATION TABLE



The ZOONLAB standing desk, made of stainless steel, can serve you as a lectern, documentation desk and storage, plus other applications in the animal husbandry sector.

The smooth-running castors also make it easy to move the standing desk. Two of the four castors are lockable. The ZOONLAB standing desk is autoclavable.

Type		Dimensions in mm (W x D x H)	Material	Order no.
Base frame with document compartment	autoclavable	650 x 470 x 1.100	Stainless steel	5115026
Option in combination with the base frame				
Printer compartment for lectern	autoclavable	591 x 447 x 300	Stainless steel	5115027
Drawer for lectern	autoclavable	532 x 326 x 150	Stainless steel	5115028
Extendable keyboard rack	autoclavable	531 x 300 x 20	Stainless steel	5115029
Inclined lectern rest for 12° inclination, applied loosely to the lectern	autoclavable	606 x 456 x 139	Stainless steel	5115024

Subject to technical modifications.

RACKS WITH SWIVEL CASTORS

RACKS FOR CONVENTIONAL HUSBANDRY

Take advantage of ZOONLAB's 70 years of experience in the manufacture of mobile racks for the storage of cages. The choice and processing of profiled tubes, in particular the hairpin brackets, avoid dirty corners and unnecessary surfaces for dust deposits. Equipped with autoclavable 100 mm dia. castors, two of them with brakes, the racks can be placed anywhere. The racks are made of high-quality AISI 304 stainless steel. The castor housings are made of stainless steel. Autoclavable covers are available as an option for the racks.



Rack with 30 type 2 L cages, single sided

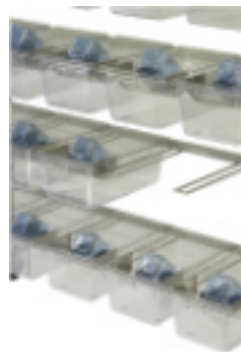

Hairpin console

Rack for	No. of levels	Single-sided/ double-sided	Dimenesions (W x D x H) in mm	Order no.
Cages Type 2 und Type 2 L - Hairpin consoles				
35 cages Type 2 / 2 L	7 levels each containing 5 cages	Single-sided	1.280 x 530 x 1.800 1.280 x 530 x *1.902	5033811
70 cages Type 2 / 2 L	7 levels each containing 10 cages	Double-sided	1.285 x 820 x 1.800 1.285 x 820 x *1.902	5033808
Cages Type 3 - Hairpin consoles				
24 cages Type 3	6 levels each containing 4 cages	Single-sided	1.280 x 530 x 1.800 1.280 x 530 x *1.902	5033814
48 cages Typ 3	6 levels each containing 8 cages	Double-sided	1.285 x 820 x 1.800 1.285 x 820 x *1.902	5033816

* With raised section and cover plate

Subject to technical modifications.

For further mobile solutions see chapter 5 Transport systems

RABBIT CAGES

INDIVIDUAL CAGES FOR RABBITS

The individual ZOONLAB rabbit cages offer optimal housing conditions in terms of size and shape, while at the same time being easy to handle, and are designed in accordance with Directive 2010/63/EU of the European Parliament of 22.09.2010 (formerly ETS 123).

The individual modules can be connected to each other, allowing the animals to have access to another cage if desired.



THEY COMBINE:

- High flexibility with linkable racks. By pulling out the side panels without the use of tools, the user can easily increase the floor space. In addition to the side coupling option, a rear coupling option is also available.
- The 10 cm high cage trays, as well as the droppings trays, are available in our proprietary autoclavable ZL material (heat resistant up to 121°C).
- The raised lying surface can be folded up and locked in place. This makes it easy to remove the cage trays without removing the lying surface.
- All metal parts are made of stainless steel 1.4301 / AISI 304.
- The swivel castors on the frames are 100 mm in diameter. The front castors have brakes.
- The racks can be optionally equipped with an automatic nipple drinking device.
- Racks and accessories for rabbits weighing up to 5 kg/ Habitat height 50 cm or 60 cm/ Running floor area 4,200 cm²



RABBIT RACK GK42 - 3 levels

MADE OF STAINLESS STEEL, AUTOCLAVABLE CAGE TRAYS



Rack GK 42-100/50-3

Type	Pcs.	Material	Dimensions (W x D x H) in mm	Order no.
Rack GK 42-100/50-3, 3 levels each containing 1 cage, 50 cm high incl. 3 grid doors	1	Stainless steel (AISI 304)	796 x 786 x 1.883	5053164
Partition wall, non transparent for 3-level rack 42-50-T	6	HPL	756 x 430	4043762
Rabbit cage, KU 42/100-ZL	3	ZL	730 x 730 x 100	3045441
Animal dropping tray, KK 4200-ZL	3	ZL	750 x 730 x 40	3094232
Raised resting area	3	ZL	1.650 cm ²	5044926S
Feed container, approx. 1,25 litres, FUKA	3	Stainless steel (AISI 304)	B = 127 H = 185	5083721
Bottle holder for 1 bottle 750 ml, FH 75/100-1	3	Stainless steel (AISI 304)	72 x 72 x 182	5121005
Water bottle, 750 ml, F 75	3	Polycarbonate	72 x 72 x 180	3125004
Silicone sealing ring, SDR 1	3	Silicone	-	3125101
Bottle cap incl. 40 mm tube with ball closure, TK-40	3	Stainless steel (AISI 304)	-	3125042
Options for rabbit cages on request				
Nesting box with side wall for GK 42 100-50-3		Stainless steel (AISI 304)	472 x 407 x 352	5063360
Partition wall, transparent for 3-level rack 42-50-T (6 mm)		Polycarbonate	756 x 430	4043763
Automatic nipple drinking device for 3-level rack , AT 42/3		Stainless steel (AISI 304)	-	On request

RABBIT RACK GK42 - 2 levels

MADE OF STAINLESS STEEL, AUTOCLAVABLE CAGE TRAYS



Rack GK 42-100/60-2

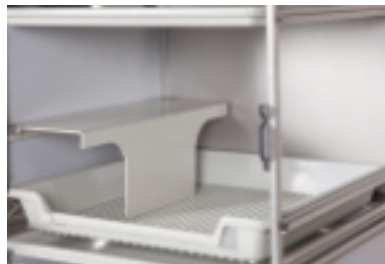

Type	Pcs.	Material	Dimensions (W x D x H) in mm	Order no.
Rack GK 42-100/60-2, 2 levels each containing 1 cage, 60 cm high incl. 2 grid doors	1	Stainless steel (AISI 304)	800 x 800 x 1.790	5053166
Partition wall, non transparent for 2level rack 42-60	4	HPL	756 x 530	4043758
Rabbit cage, KU 42/100-ZL	2	ZL	730 x 730 x 100	3045441
Animal dropping tray, KK 4200-ZL	2	ZL	750 x 730 x 40	3094232
Raised resting area	2	ZL	1.650 cm ²	5044926S
Feed container, approx. 1,25 litres, FUKA	2	Stainless steel (AISI 304)	B = 127 H = 185	5083721
Bottle holder for 1 bottle 750 ml, FH 75/100-1	2	Stainless steel (AISI 304)	72 x 72 x 182	5121005
Water bottle, 750 ml, F 75	2	Polycarbonate	72 x 72 x 180	3125004
Silicone sealing ring, SDR 1	2	Silicone	-	3125101
Bottle cap incl. 40 mm tube with ball closure, TK-40	2	Stainless steel (AISI 304)	-	3125042
Options for rabbit cages on request				
Nesting box with side wall for GK 42 100-60-2		Stainless steel (AISI 304)		5063359
Partition wall, transparent for 2-level rack 42-60		Polycarbonate	756 x 530	4043759
Automatic nipple drinking device for 2-level rack , AT 42/2		Stainless steel (AISI 304)	-	On request



RABBIT RACK GK54 - 3 levels

MADE OF STAINLESS STEEL, AUTOCLAVABLE CAGE TRAYS

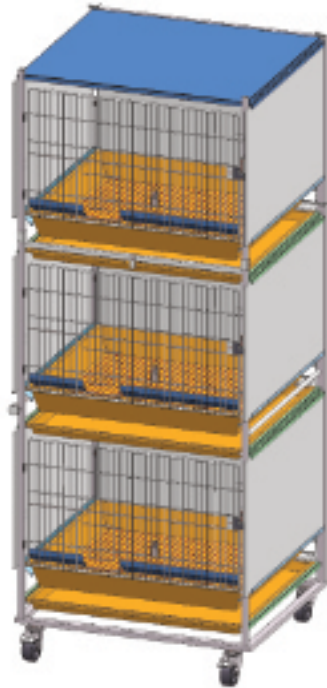

Rack GK 54/3-60

Type	Pcs.	Material	Dimensions (W x D x H) in mm	Order no.
Rack GK 54/3-60, 3 levels each containing 1 cage, 60 cm high incl. 3 grid doors , top level can be removed	1	Stainless steel (AISI 304)	940 x 860 x 2.300	5053149
Partition wall, non transparent for 3-level rack 54-60-T	6	HPL	820 x 540	4043752
Rabbit cage, KU 5400 -ZL	3	ZL	855 x 775 x 100	3045440
Animal dropping tray, KK 5400-ZL	3	ZL	855 x 775 x 40	3094233
Raised resting area	3	ZL	1.945 cm ²	5044927S
Feed container, approx. 1,25 litres, FUKA	3	Stainless steel (AISI 304)	B = 125 H = 185	5083721
Bottle holder for 1 bottle 750 ml, FH 75/100-1	3	Stainless steel (AISI 304)	-	5121005
Water bottle, 750 ml, F 75	3	Polycarbonate	72 x 72 x 180	3125004
Silicone sealing ring, SDR 1	3	Silicone	-	3125101
Bottle cap incl. 40 mm tube with ball closure, TK-40	3	Stainless steel (AISI 304)	-	3125042
Options for rabbit cages on request				
Nesting box with side wall for GK 54		Stainless steel (AISI 304)	472 x 407 x 352	5063362
Partition wall, transparent, 54-60 M		Polycarbonate	820 x 540	4043753
Hay rack		Stainless steel (AISI 304)	-	5083789
Automatic nipple drinking device for 3-level rack , AT 54/3		Stainless steel (AISI 304)	-	On request

RABBIT RACK GK54 - 2 levels

MADE OF STAINLESS STEEL, AUTOCLAVABLE CAGE TRAYS

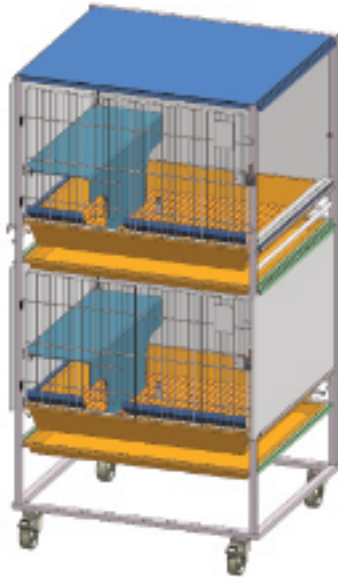

Rack GK 54/2-60 , connectable



Type	Pcs.	Material	Dimensions (W x D x H) in mm	Order no.
Rack GK 54/2-60, 2 levels each containing 1 cage, 60 cm high incl. 2 grid doors	1	Stainless steel (AISI 304)	938 x 859 x 1781	5053144
Partition wall, non transparent, 54-60-T	4	HPL	820 x 540	4043752
Rabbit cage, KU 5400 -ZL	2	ZL	855 x 775 x 100	3045440
Animal dropping tray, KK 5400-ZL	2	ZL	855 x 775 x 40	3094233
Raised resting area	2	ZL	1.945 cm ²	5044927S
Feed container, approx. 1,25 litres, FUKA	2	Stainless steel (AISI 304)	B = 127 H = 185	5083721
Bottle holder for 1 bottle 750 ml, FH 75/100-1	2	Stainless steel (AISI 304)	-	5121005
Water bottle, 750 ml, F 75	2	Polycarbonate	72 x 72 x 180	3125004
Silicone sealing ring, SDR 1	2	Silicone	-	3125101
Bottle cap incl. 40 mm tube with ball closure, TK-40	2	Stainless steel (AISI 304)	-	3125042
Options for rabbit cages on request				
Nesting box with side wall for GK 54		Stainless steel (AISI 304)		5063362
Partition wall, transparent, 54-60 M		Polycarbonate	820 x 540	4043753
Hay rack		Stainless steel (AISI 304)	-	5083789
Automatic nipple drinking device for 3-level rack , AT 54/2		Stainless steel (AISI 304)	-	On request



RABBIT RACK WITH NESTING DRAWER

MADE OF STAINLESS STEEL, AUTOCLAVABLE CAGE TRAYS



Available as double rack only

Type	Pcs.	Material	Dimensions (W x D x H) in mm	Order no.
Rack for rabbits with nesting drawer	1	Stainless steel (AISI 304)	1800 x 848 x 1675	5053174
Cage consisting of:				
Nesting drawer	2	ZL	837 x 837 x 753	
Animal floor 5558 cm ²	2	ZL	836 x 808 x 8	
Animal coner toilett	2	Plastic		
Raised resting area	2	ZL	735 x 350 x 300	5044927S
Feed container, approx. 1,25 litres, FUKA	2	Stainless steel (AISI 304)	W = 127 H = 185	5083721
Bottle holder for 1 bottle 750 ml, FH 75/100-1	2	Stainless steel (AISI 304)		5121005
Water bottle, 750 ml, F 75	2	Polycarbonate	72 x 72 x 180	3125004
Silicone sealing ring, SDR 1	2	Silicone		3125101
Bottle cap incl. 40 mm tube with ball closure, TK-40	2	Stainless steel (AISI 304)		3125042

GUINEA PIG CAGES

INDIVIDUAL CAGES FOR GUINEA PIGS

The individual ZOONLAB cages for guinea pigs provide ideal conditions for animal husbandry in terms of size and shape and are easy to use. They can be adapted for keeping mice and rats and other small animals.



The guinea pig cages are placed in mobile racks with autoclavable castors, two of which have brakes.



Hut for Guinea Pig 3084051



RACK FOR GUINEA PIGS - 5 levels

INDIVIDUAL CAGES FOR GUINEA PIGS



Rack for guinea pigs, GM5, 5 cages



MZK 25 with complete cover lid

Type	Pcs.	Material	Dimensions (W x D x H) in mm	Order no.
Rack for 5 cages, GM 5	1	Stainless steel (AISI 304)	917 x 745 x 1.973	5053101
Guinea pig cage MZK ZL, autoclavable up to 121°C	5	ZL	810 x 610 x 260	3045322
Front grid, MZK-V	5	Stainless steel (AISI 304)	-	5043901
Cover lid with sliding opening, MZK-A	5	Stainless steel (AISI 304)	-	5043902
Feed container, FUMZK	5	Stainless steel (AISI 304)	B 162/ H 170/ T 135	5083724
Bottle holder for 2 bottles , 750 ml, FH 75/2	5	Stainless steel (AISI 304)	-	5121003
Water bottle, 750 ml, F 75	10	Polycarbonate	72 x 72 x 180	3125004
Silikone sealing ring, SDR 1	10	Silicone	-	3125101
Bottle cap incl. 40 mm tube with ball closure, TK-40	10	Stainless steel (AISI 304)	-	3125042
Options for guinea pig cages on request				
Wired grid for cage floor, mesh gap approx. 10 x 30 mm, MZK-EB		Stainless steel (AISI 304)	-	5013080
Guinea pig house, autoclavable, stackable, non toxic		Polycarbonate	205 x 157 x 115	3084051

RACK GM 10, DOUBLE RACK FOR GUINEA PIGS

INDIVIDUAL CAGES FOR GUINEA PIGS



Rack for guinea pigs, GM10 with 10 cages

Type	Pcs.	Material	Dimensions (W x D x H) in mm	Order no.
Rack for 10 cages, GM 10, 2 cages each level	1	Stainless steel (AISI 304)	1.765 x 745 x 1.975	5053102
Guinea pig cage MZK ZL, autoclavable up to 121°C	10	ZL	810 x 610 x 260	3045322
Front grid, MZK-V	10	Stainless steel (AISI 304)	-	5043901
Cover lid with sliding opening, MZK-A	10	Stainless steel (AISI 304)	-	5043902
Feed container, FUMZK	10	Stainless steel (AISI 304)	-	5083724
Bottle holder for 2 bottles , 750 ml, FH 75/2	10	Stainless steel (AISI 304)	-	5121003
Water bottle, 750 ml, F 75	20	Polycarbonate	72 x 72 x 180	3125004
Silikone sealing ring, SDR 1	20	Silicone	-	3125101
Bottle cap incl. 40 mm tube with ball closure, TK-40	20	Stainless steel (AISI 304)	-	3125042
Options for guinea pig cages on request				
Wired grid for cage floor, mesh gap approx. 10 x 30 mm, MZK-EB		Stainless steel (AISI 304)	-	5013080
Guinea pig house, autoclavable, stackable, non toxic		Polycarbonate	205 x 157 x 115	3084051



RACK FOR GUINEA PIGS - 4 levels

INDIVIDUAL CAGES FOR GUINEA PIGS



Rack GM 4 with 4 cages

Type	Pcs.	Material	Dimensions (W x D x H) in mm	Order no.
Rack for 4 cages, GM 4	1	Stainless steel (AISI 304)	920 x 745 x 1.650	5053103
Guinea pig cage MZK ZL, autoclavable up to 121°C	4	ZL	810 x 610 x 260	3045322
Front grid, MZK-V	4	Stainless steel (AISI 304)	-	5043901
Cover lid with sliding opening, MZK-A	4	Stainless steel (AISI 304)	-	5043902
Feed container, FUMZK	4	Stainless steel (AISI 304)	-	5083724
Bottle holder for 2 bottles, 750 ml, FH 75/2	4	Stainless steel (AISI 304)	-	5121003
Water bottle, 750 ml, F 75	8	Polycarbonate	72 x 72 x 180	3125004
Silicone sealing ring, SDR 1	8	Silicone	-	3125101
Bottle cap incl. 40 mm tube with ball closure, TK-40	8	Stainless steel (AISI 304)	-	3125042
Options for guinea pig cages on request				
Wired grid for cage floor, mesh gap approx. 10 x 30 mm, MZK-EB		Stainless steel (AISI 304)	-	5013080
Guinea pig house, autoclavable, stackable, non toxic		Polycarbonate	205 x 157 x 115	3084051

RACK GM 8, DOUBLE RACK FOR GUINEA PIGS

INDIVIDUAL CAGES FOR GUINEA PIGS



Rack GM8 with 8 cages

Type	Pcs.	Material	Dimensions (W x D x H) in mm	Order no.
Rack for 8 cages, GM 8, 2 cages each level	1	Stainless steel (AISI 304)	1754 x 745 x 1650	5053106
Guinea pig cage MZK ZL, autoclavable up to 121°C	8	ZL	810 x 610 x 260	3045322
Front grid, MZK-V	8	Stainless steel (AISI 304)	-	5043901
Cover lid with sliding opening, MZK-A	8	Stainless steel (AISI 304)	-	5043902
Feed container, FUMZK	8	Stainless steel (AISI 304)	-	5083724
Bottle holder for 2 bottles, 750 ml, FH 75/2	8	Stainless steel (AISI 304)	-	5121003
Water bottle, 750 ml, F 75	16	Polycarbonate	72 x 72 x 180	3125004
Silicone sealing ring, SDR 1	16	Silicone	-	3125101
Bottle cap incl. 40 mm tube with ball closure, TK-40	16	Stainless steel (AISI 304)	-	3125042
Options for guinea pig cages on request				
Wired grid for cage floor, mesh gap approx. 10 x 30 mm, MZK-EB		Stainless steel (AISI 304)	-	5013080
Guinea pig house, autoclavable, stackable, non toxic		Polycarbonate	205 x 157 x 115	3084051



GUINEA PIGS IN CAGES, RAISED COVER LID

INDIVIDUAL CAGES FOR GUINEA PIGS

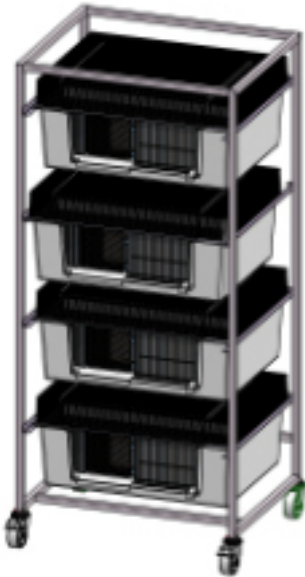

Rack for guinea pigs with 100 mm raised cover lid

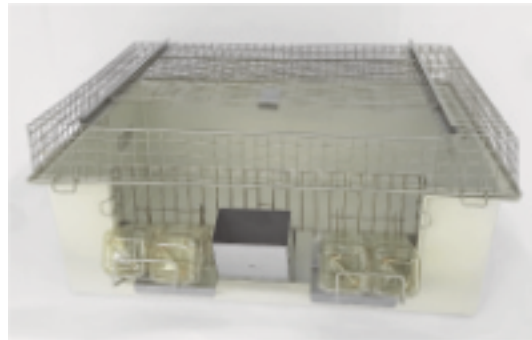

MZK 80/25 with raised cover lid (mesh 20 x 20 mm Ø 2 mm)

Type	Pcs.	Material	Dimensions (W x D x H) in mm	Order no.
Rack for 4 cages, GM4 100 mm raised, habitat height 350 mm	1	Stainless steel (AISI 304)	920 x 745 x 1.910	5053107
Guinea pig cage MZK ZL, autoclavable up to 121°C	4	ZL	810 x 610 x 260	3045322
Front grid, MZK-V	4	Stainless steel (AISI 304)	-	5043901
Cover lid with sliding opening, MZK-A	4	Stainless steel (AISI 304)	-	5043904
Feed container, FUMZK	4	Stainless steel (AISI 304)	-	5083724
Bottle holder for 2 bottles , 750 ml, FH 75/2	4	Stainless steel (AISI 304)	-	5121003
Water bottle, 750 ml, F 75	8	Polycarbonate	72 x 72 x 180	3125004
Silikone sealing ring, SDR 1	8	Silicone	-	3125101
Bottle cap incl. 40 mm tube with ball closure, TK-40	8	Stainless steel (AISI 304)	-	3125042
Guinea pig cage options				
Wired grid for cage floor, mesh gap approx. 10 x 30 mm, MZK-EB		Stainless steel (AISI 304)	-	5013080
Guinea pig house, autoclavable, stackable, non toxic		Polycarbonate	205 x 157 x 115	3084051

GUINEA PIG HOUSING IN THE UNIPROTECT

AIR FLOW HOUSING OF GUINEA PIGS



Type	Pcs.	Material	Dimensions (W x D x H) in mm	Order no.
Guinea pig cage MZK ZL, autoclavable up to 121°C	1	ZL	810 x 610 x 260	3045322
Front grid, MZK-V	1	Stainless steel (AISI 304)	-	5043901
Cover lid with sliding opening, MZK-A	1	Stainless steel (AISI 304)	-	5043902
Feed container, FUMZK	1	Stainless steel (AISI 304)	-	5083724
Bottle holder for 2 bottles , 300 ml, F30	1	Stainless steel (AISI 304)	-	5043909
Water bottle, 300 ml, F 30	2	Polysulfone	-	3125028
Silikone sealing ring, SDR 3	2	Silicone	-	3125116
Bottle cap incl. 40 mm tube with ball closure, TK-40	2	Stainless steel (AISI 304)	-	3125042



„RACK GUINEA PIG“ MODIFIED FOR RATS

INDIVIDUAL CAGES FOR RATS

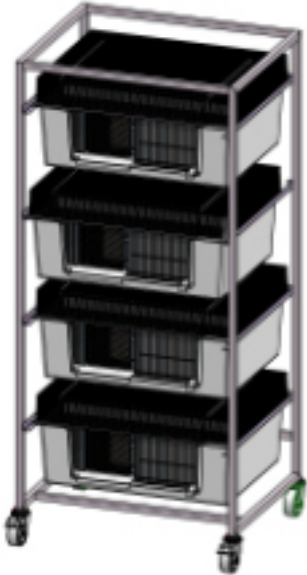

Rack guinea pig modified for rats



MZK 25 with raised cover lid for mice and rat housing

Type	Pcs.	Material	Dimensions (W x D x H) in mm	Order no.
Rack for 4 cages, GM 4, 100 mm raised, habitat height 350 mm	1	Stainless steel (AISI 304)	920 x 745 x 1.910	5053107
Guinea pig cage MZK ZL, autoclavable up to 121°C	4	ZL	810 x 610 x 260	3045322
Front grid for rats and mice	4	Stainless steel (AISI 304)	-	5043911
Cover lid with sliding opening, 100 mm raised, for rats and mice	4	Stainless steel (AISI 304)	-	5043905
Feed container, FUMZK	4	Stainless steel (AISI 304)	-	5083724
Bottle holder for 2 bottles	4	Stainless steel (AISI 304)	-	
Water bottle, F30, 300 ml	8	Polysulfone	-	3125028
Silicone sealing ring, SDR 3	8	Silicone	-	3125116
Bottle cap 40 mm, TR 40/1.8	8	Stainless steel (AISI 304)	-	3125032

RAT HOUSING IN THE PLAYGROUND

INDIVIDUAL CAGES FOR RATS, MICE AND OTHER SMALL ANIMALS

Floor Space	~ 3770 cm ²
Mice	No. of animals
< 20 g	62
20 – 25 g	53
25 – 30 g	47
> 30 g	37
Rats	
< 200 g	18
200 – 300 g	15
300 – 400 g	10
400 – 600 g	8
> 600 g	6

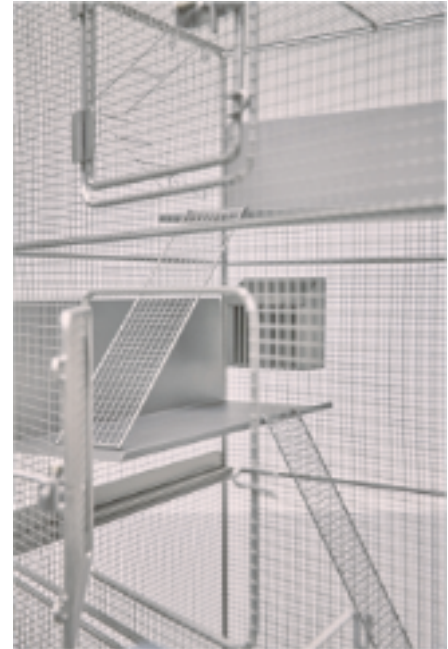

Housing capacities for rats: 10 animals weighing less than 400 g or 8 animals weighing between 400 - 600 g or 6 animals weighing more than 600 g can be kept in the Playground-cage.

Type	Pcs.	Material	Dimensions (W x D x H) in mm	Order no.
Playground-cage		Stainless steel (AISI 304)	720 x 522 x 1014	5033980
Rack for Playground (1 cage)		Stainless steel (AISI 304)	835 x 550 x 730	5033993
Rack for Playground (2 cages)		Stainless steel (AISI 304)	1570 x 550 x 730	5033988
1 Cage consisting of:				
Dropping tray of the cage	1	Stainless steel (AISI 304)	964 x 495 x 31	5033989
Divider for cage levels	2	Stainless steel (AISI 304)	650 x 485	5033994
Resting area 118 mm ²	1	Stainless steel (AISI 304)	677 x 175 x 150	5033983
Resting area 81 mm ²	2	Stainless steel (AISI 304)	463 x 175 x 150	5033984
Ladder 375 mm	1	Stainless steel (AISI 304)	83,5 x 375	5033985
Ladder 279 mm	1	Stainless steel (AISI 304)	83,5 x 279	5033987
Ladder 600 mm	1	Stainless steel (AISI 304)	83,5 x 600	5033986
Feeding container	2	Stainless steel (AISI 304)	125 x 71 x 126	5033981
Bottle holder for one bottle	2	Stainless steel (AISI 304)	82 x 134 x 218	5121029
Silicone sealing ring, SDR 1	2	Silicone		3125101
Water bottle, 750 ml, F 75	2	Polycarbonate	72 x 72 x 180	3125004
Bottle cap, TK-40, 1.8	2	Stainless steel (AISI 304)		3125032

IVC RACKS AND CAGES

FOR AIR FLOW SYSTEMS TYPE VENT LT

ZOONLAB BIO. A.S.[®] IVC systems ensure high biological safety, easy and ergonomic handling and conformity with the 2010/63/EU Directive of the European Parliament.

With typical use, the rack only needs to be cleaned every 12 to 16 months.

Made of stainless steel, the Vent LT BIO. A.S.[®] for IVC cages are lightweight and easy to use. The racks can be prepared for cleaning without tools. The racks have a separate air inlet and outlet for each cage and the round tubes improve air circulation and facilitate cleaning.



Vent LT BIO. A.S.[®] I with IVC rack



IVC cage Type 2 L



IVC RACKS AND CAGES

FOR AIR FLOW SYSTEMS



- Separate supply and exhaust air connection for each cage
- Round tubes for improved air circulation and easier cleaning
- Tool-free disassembly and reassembly
- Round tubes for improved air circulation
- Round tubes for improved cleaning

Type VENT LT Bio.A.S.®			Outer dimensions in mm (W x H x D) *	Order no.
for 48 cages Type 2 L	Single-sided	8 levels x 6 cages	1450 x 1935 x 560	5144264
for 96 cages Type 2 L	Double-sided	8 levels x 6 cages	1450 x 1935 x 860	5144266
for 64 cages Type 2 L	Single-sided	8 levels x 8 cages	1890 x 1935 x 560	5144265
for 128 cages Type 2 L	Double-sided	8 levels x 8 cages	1890 x 1935 x 860	5144268
for 24 cages Type 3	Single-sided	6 levels x 4 cages	1250 x 1935 x 620	5144272-1
for 48 cages Type 3	Double-sided	6 levels x 4 cages	1250 x 1935 x 980	5144276
for 30 cages Type 3	Single-sided	6 levels x 5 cages	1530 x 1935 x 620	5144273
for 60 cages Typ 3	Double-sided	6 levels x 5 cages	1530 x 1935 x 980	5144277
for 42 cages Typ 3	Single-sided	6 levels x 7 cages	2090 x 1935 x 620	5144275

Further options on request.

* The external dimensions of the frames are given without wall deflectors.

IVC CAGES

ZOONLAB IVC cages offer a wide range of versions as well as a wide variety of options to optimally suit your needs. In addition, the complete cages are autoclavable.

- Cages of polycarbonate up to a max. temperature of 121°C
- Cages of polysulfone up to max. temperature of 134°C

IVC CAGES TYPE 2 L

Type 2 L cages offer sufficient space for various enrichment to be placed.

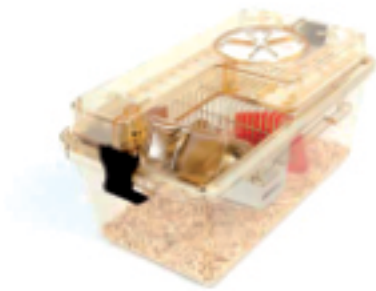

Complete IVC cage type 2 L incl. cage, stainless steel lid, filter level, filter top with CO₂ membrane and water bottle.



stainless steel lid with hinged divider for 2 L type cage

Type	Order no.
DST 2 L F2eOf	5023481-2



Filter top with CO₂ membrane and securing lips for 2 L type cage

Type	Order no.
Filter top	5010924S

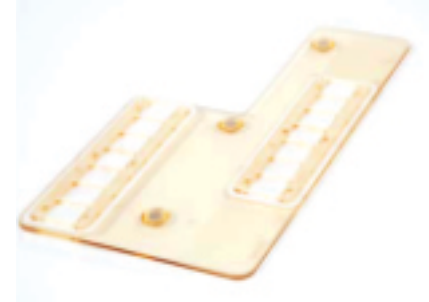

Filter level consisting of ventilation cover, holding frame and filter pad for 2 L type filter top

Type	Order no.
Filter level 2 L	5010941S

CAGES

Type	Description	Dimensions in mm (W x D x H)
2 L	Cages and filter tops available in polycarbonate and polysulfone, filter levels only available in polysulfone	365 x 205 x 140 mm Cage floor size: 530 cm ²
3 *	Cages and filter tops available in polycarbonate and polysulfone, filter levels only available in polysulfone	425 x 265 x 150 mm Cage floor size: 830 cm ²

Minimum order quantity 250 pieces for polycarbonate, for polysulfone only on request



IVC RACKS AND CAGES

FOR AIR FLOW SYSTEMS

Below you will find options for the different cage sizes with the respective order numbers. Please note that some items are available in polycarbonate (PC) and polysulfone (PSU).

Cages	2 L	3 *
Cages, standard	PC 3010034 PSU 3010041	PC 3010003 PSU 3010048
Lid (compare to chapter 1)		
Stainless steel lid with hinged divider	5023481-2	5023483
Filter tops		
Bio. A.S.® filter top, closed, with securing clamps for external water bottle	PSU 5010918S	
Bio. A.S.® filter top, with CO ₂ -membrane, with securing clamps for external water bottle	PSU 5010924S	PSU 5010925S
Filter levels		
Filter level consisting of cover, frame and pad	PSU 5010941S	PSU 5010942S
Water bottle (compare to chapter 1)		
Water bottle F 30, 300 ml, square	PSU 3125028	PSU 3125028
Water bottle F 40, 400 ml, square (Only compatible with type 3 silicone sealing ring)	PC 3125005	PC 3125005
Bottle cap, stainless steel, 40 mm tube with 1,8 mm hole	3125032	3125032
Silicone sealing ring Type 1, full rubber, smooth	3125101	3125101
Silicone sealing ring, Type 3, full rubber, ribbed	3125116	3125116
Holder for cards (compare to chapter 1)		
Landscape for DIN A7 cards, made of stainless steel, with wire hanger for filter tops	3104507	3104507
Portrait for DIN A7 cards, made of stainless steel	5104514	5104514
Portrait for DIN A7 cards, made of polysulfone with stainless steel wire hanger	5104513S	5104513S

* Minimum order quantity 250 pcs. for polycarbonate, for polysulfone only on request

** With hinged divider

VENT LT BIO.A.S. ® BLOWER UNIT

AIR FLOW SYSTEMS

Reliable, safe and easy to use for air supply at the highest level of pressure control technology in rugged design with lateral connection.





VENT LT BIO.A.S. ® VENT LT BIO.A.S. ®

BLOWER UNIT

ZOONLAB blower units are characterized by their easy operation and reliability. Unlike other suppliers, all units are pressure-regulated, which maximizes the operational safety of the animal habitat by providing a reliable air supply. Important parameters such as **air exchange rate, volume flow, pressure conditions, temperature and humidity** are monitored with maximum and minimum alarm limits, thus ensuring maximum safety for your animals.

The system also boasts the following functions:

- Temperature monitoring with adjustable upper and lower alarm limits
- Air humidity monitoring with adjustable upper and lower alarm limits
- Monitoring of the supply and exhaust air filters
- Connections for the filter integrity test (DEHS)
- Low-contamination filter change, practical positioning of the filters on the front of the device
- Plug connection for external function (e.g. GLT)
- Interface for visualisation, recording and monitoring
- Operating hour counter / display of total runtime
- Operating hour counter / with information for filter change
- Operating hour counter / with information for the next service
- Connections for gassing with H₂O₂
- Airflow with large volume for ideal and homogeneous distribution of the air



VENT LT BIO.A.S.®
Blower Unit



Pullout for preliminary filter



Pullout for main filter

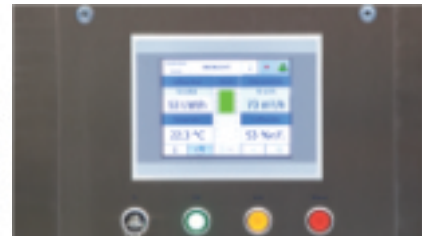

Touch panel

Capacity: 340 Type 1 L cages or 250 Type 2 L cages or 170 Type 3 cages

Electrical connection	230 V/ 50 Hz
Electrical output	0.08 - 0.22 kW, average value of 0.15 kW/EC motors
Heat dissipation	0.04 kW
Preliminary filter	G4 according to EN 779
Main filter	HEPA H14 according to EN 1822
Dimensions (W x H x D) in mm	400 x 1.650 x 534 mm
Weight	88 kg
Order no.	5144207

Subject to technical modifications.

UNIPROTECT NG

PRODUCT INFORMATION

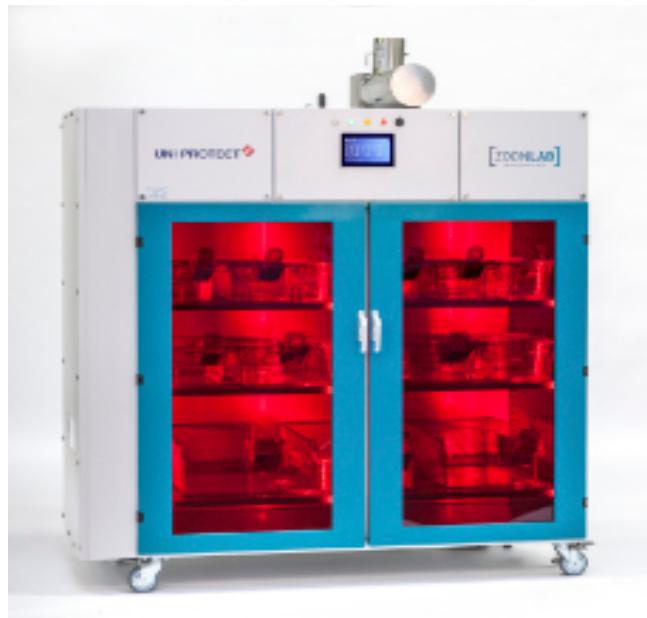

UNIPROTECT NG FOR KEEPING LABORATORY ANIMALS UNDER CLIMATE-CONTROLLED CONDITIONS

AIR FLOW CABINET WITH PRESSURE AND HUMIDITY REGULATION AND INTUITIVE OPERATING MENU

YOUR BENEFITS AT A GLANCE

- Active pressure regulation to maintain the hygiene barrier and protect both rodents and the laboratory environment
- Fully integrated humidifier module to create ideal climate conditions
- LED lighting system with red acrylic glass doors and daily / weekly timer, including automated sunrise and sunset for the natural biorhythms of the lab animals
- Barrier-free access to the holding space for comfortable handling
- Configurable alarms and notifications with forwarding to the building control system
- Conformant with Directive 2010/63/EU¹ and the recommendations of the German Society for Laboratory Animal Science (GV Solas) for keeping test animals

¹Directive 2010/63/EU of the European Parliament and of the Council of 22. September 2010 on the protection of animals used for scientific purposes



UNIPROTECT NG

PRODUCT INFORMATION

Animal keeping cabinets are frequently utilised by laboratories that conduct animal testing. These cabinets complement established animal housing systems in an SPF (specific pathogen-free) environment that is hygienically strictly controlled, for breeding lines and rare species that have to be kept under special climatic conditions or deviating lighting cycles. Air flow cabinets are thus particularly suitable for use in experimental, laboratory and quarantine applications. The new UniProtect NG represents the next generation of air flow cabinets, developed by ZOONLAB precisely for these needs.

UNIPROTECT NG: FOR THE PROTECTION AND WELL-BEING OF LABORATORY ANIMALS

Animal housing systems conformant with guidelines and animal protection laws have to fulfil stringent requirements, and that is what UniProtect NG does: A fully integrated humidity module (optional) in combination with precise temperature control affords optimal climatic conditions for keeping rodents and small test animals. The air flow cabinet is equipped with an innovative lighting system based on modern LED technology for maintaining natural biorhythms. The system allows continuous adjustment of light intensity and programming of day-night cycles with fade-in/fade-out function. Enhanced soundproofing reduces the sound level in the interior to less than 55 dB(A).

The protection of humans and of the environment, in addition to the well-being of the animal, are additional development focuses for this product. Active pressure control reduces the risk of contamination in case of overpressure or low-pressure operation through constant adjustment of differential pressure. The filter system installed in the in-duct and out-duct with pre- and main filter (HEPA filter H14) ensures efficient reduction of pathogenic and allergenic particles in room air. Pressure control, filter system and continuous monitoring of basic parameters guarantee a high level of operational safety, rounded out by individually configurable error reporting technology that can be integrated into building control systems.

INNOVATIONS FOR A PROVEN TECHNOLOGY

Sometimes many little upgrades add up to a substantial improvement of routine daily operations. In the new NG series for example, the middle door stop was replaced with mutually closing doors. In addition to the improved visibility, accessing the cabinet interior has been made easier and usability of the utility space has been increased. All operating parameters can be quickly and easily entered via a modern, 7" colour touch panel. Additionally, users can access the UniProtect NG controls from outside the animal room. After integration into the in-house network, the included software can be used to perform the full range of functions for external monitoring and convenient air flow cabinet control. Tool-free, low-contamination filter changing is possible without stopping operation. The stainless steel interior surfaces are easy to clean and disinfect. These and other adaptations translate to an easier handling in day-to-day laboratory practice.

UNIPROTECT NG

PRODUCT INFORMATION



MODERN, USER-FRIENDLY INTERFACE

- High-resolution 7.0" colour touch panel with integrated microprocessor
- Sensitive user touch surface and intuitive menu guidance for quick and easy operation
- Well-organised reporting of operating hours and other indicators
- USB interface for documenting recorded operating parameters
- New security feature: Password-protected settings for flexible user administration



UNIPROTECT NG

PRODUCT INFORMATION

STANDARD PRODUCT FEATURES

- 7" TFT colour touch panel with integrated controls
- Intuitive menu navigation
- Operating hours counter and set point and actual value display integrated into the Human Machine Interface (HMI)
- Disinfection program (integrated in the HMI)
- Operating parameter trend display (integrated in the HMI)
- Monitoring and alarm system (integrated in the HMI)
- Separate usage time monitoring for supply and exhaust air filters
- USB interface for connecting storage media
- Barrier-free access to cage room
- Two doors with red acrylic panes
- H 14 HEPA filter system tested for DIN EN 1822 and optional DEHS conformity
- Supply and exhaust air with filter monitoring and DEHS measurement device
- Contamination-free filter changing
- Automated control of chamber pressure with setpoint configuration
- Overpressure and low-pressure operation; change operating mode by entering the desired differential pressure (input in Pascal/Pa)
- Lighting in white and red with lighting change control via daily or weekly timer (integrated in the HMI)
- Exhaust ports connect direct to the building exhaust air system
- Heating with automated chamber temperature control
- Homogeneous air distribution on all cabinet levels
- Outer housing of stainless steel / 1.4301, powder-coated
- Utility space of stainless steel / 1.4301, easy to clean and disinfect
- Four steering rollers for moving, with locking front rollers
- Extra adjustable stands for greater stability
- Four utility areas: Floor area and three shelves of stainless steel / 1.4301, height-adjustable and removable

OPTIONAL COMPONENTS AND FUNCTIONS

- Network-integratable, controllable via LAN
- GLP-/GMP-compliant recorder for tamper-proof data gathering
- Humidity control for ideal climatic conditions
- Automatically switchable cooling units for short-term air conditioning
- Activated carbon filter replaceable with no tools required
- Under-cabinet area in raised design
- Additional fourth insertable shelf and ESG glass panes
- Maintenance and service contract
- Activity-tracking with the module „Revolyzer“

UNIPROTECT NG

AVAILABLE IN SIZES S, M AND L

UniProtect NG (S)	Capacity (n)	Interior dimensions (W x D x H / volume) (mm) / (l)	Exterior dimensions (W x D x H) (mm)	Order no.
3 levels, height-adjustable (32-mm adjustment grid); removable plus bottom space	32 Type 2	947 x 670 x 1.250 mm 850 l	1.050 x 798 x 1.808 mm	5144431
	16 Type 2 L			
	12 Type 3			
	8 Type 4			
	4 GPBC ¹			
Options				
Humidifier module	–	–	1.243 x 798 x 1.808 mm	3144071
Activated carbon filter	–	–	1.050 x 798 x 2.110 mm	3144070

UniProtect NG (M)	Capacity (n)	Interior dimensions (W x D x H / volume) (mm) / (l)	Exterior dimensions (W x D x H) (mm)	Order no.
3 levels, height-adjustable (32-mm adjustment grid); removable plus bottom space	48 Type 2	1.450 x 675 x 1.250 mm 1.210 l	1.550 x 798 x 1.808 mm	5144440
	24 Type 2 L			
	20 Type 3			
	12 Type 4			
	4 GPBC ¹			
Options				
Humidifier module	–	–	1.743 x 798 x 1.808 mm	3144071
Activated carbon filter	–	–	1.550 x 798 x 2.112 mm	3144070

UniProtect NG (L)	Capacity (n)	Interior dimensions (W x D x H / volume) (mm) / (l)	Exterior dimensions (W x D x H) (mm)	Order no.
3 levels, height-adjustable (32-mm adjustment grid); removable plus bottom space	64 Type 2	1.860 x 670 x 1.250 mm 1.570 l	1.960 x 798 x 1.808 mm	5144450
	32 Type 2 L			
	24 Type 3			
	16 Type 4			
	8 GPBC ¹			
Options				
Humidifier module	–	–	2.150 x 798 x 1.808 mm	3144071
Activated carbon filter	–	–	1.960 x 798 x 2.110 mm	3144070

¹GPBC: Guinea pig breeding cage (dimensions: 810 x 260 x 610 mm) | technical changes reserved.

EXPOSURE LINE - CO₂ BOX

AIR FLOW SYSTEMS





EXPOSURE LINE - CO₂ BOX

AIR FLOW SYSTEMS

Innovation for routine operation and research. The PLC-controlled CO₂ Box, developed by ZOONLAB, permits the application of gases and gas compounds in a reproducible process for the very first time. The induction phase is first carried out with oxygen and successively supplemented with carbon dioxide to ensure that the animals fall asleep. Therefore two gases are required with this equipment. Consequently, the ZOONLAB CO₂ Box meets all established recommendations and statutory provisions for euthanasia of small rodents using CO₂.

Function and equipment:

- Programmable mixing ratio of 2 gases
- Programmable volume flow of gas compound
- Programmable time sequences
- Controllable processes
- Easy handling
- High operational safety
- Password-protected operating panel
- Up to 20 customer-specific programmes can be stored alongside the standard programmes
- Trend recording of all processes, displayed by graph
- Scope of delivery does not include the base frame

Options:

- Base frame



Description	Holding capacity	Order No.	Order No.
CO ₂ Box	Cage type	CO ₂ Box	Base frame
Modell M, (Volume 115 l) Chamber dimensions (H xDxH) 600 x 640 x 300 mm External dimensions (B xT x H) 1.000 x 725 x 520 mm	4 x Typ 1 L (160 x 362) 4 x Typ 2 (205 x 265) 3 x Typ 2 L (205 x 365) 2 x Typ 3 (265 x 425) 1 x Typ 4 (380 x 590)	5144501	5144506
Modell L, (Volume 180 L) Chamber dimensions (H xDxH) 935 x 640 x 300 mm External dimensions (B xT x H) 1.334 x 725 x 520 mm	7 x Typ 1 L (160 x 362) 8 x Typ 2 (205 x 265) 6 x Typ 2 L (205 x 365) 4 x Typ 3 (265 x 425) 2 x Typ 4 (380 x 590)	5144502	5144504

Subject to technical modifications.

ZL MULTIONE

AIR FLOW SYSTEMS

The ZL MultiOne is a newly developed device for CO₂ euthanasia of IVC cages at the workplace.

Due to the innovative design, both type 2 L and type 3 cages can be connected. The ZL MultiOne recognizes the cage and automatically starts a gassing process after docking. The automatic flow adjustment ensures that only the required amount of CO₂ enters the cage. Depending on the model, a session takes between 6 and 8 minutes.

The ZL MultiOne is designed for ZOONLAB cages. However, cages from other manufacturers can also be used when equipped with special adapters. Thus, we guarantee compatibility of cages of the Green and Blueline Tecniplast series as well as cages of the NextGen series of the manufacturer Allentown.

A simple LED display on the unit visualizes the three different operating modes "Session Ready", "In Progress" and "Completed." The ZL MultiOne can be operated with a portable CO₂ cylinder as well as on the mains at 2 bar pressure.

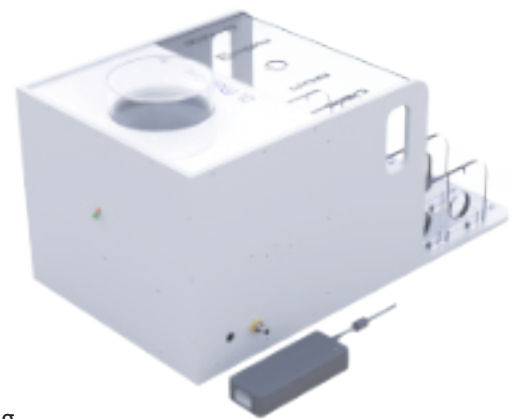
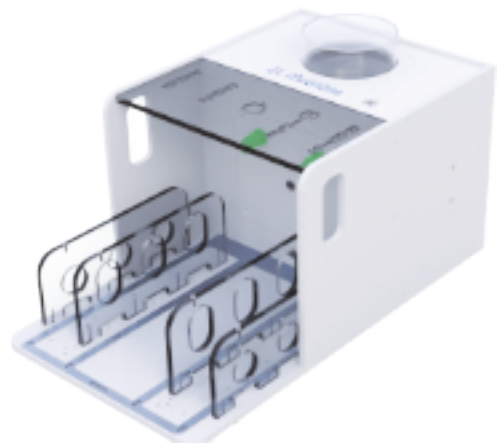

Technical Details:

- Adapter for cages type 2 L and type 3
- Auto-start function by recognition of the cages upon docking
- Automatic sequence with induction phase, euthanasia phase and flushing phase
- Session duration: 6-7 minutes for cage type 2 L, 7-8 minutes for type 3
- Special adapters for Greenline, Blueline (Tecniplast), for Nexgen (Allentown) and ZOONLAB
- LED indicators for "session ready", "in progress" or "completed"
- Connection for CO₂ bottle or mains 2 bar pressure
- Soda lime filter and/or external exhaust port
- Air purifier to purge the CO₂ from the cage at the end of the session

Description	Cages	Order No.
Outer dimension (W x D x H) 380 x 670 x 320 mm	ZOONLAB Typ 2 L / 3	53144408
	TP - Greenline Typ 2 L / 3	53144409
	TP - Blueline Typ 2 L / 3	53144410
	Allentown Typ 2 L / 3	53144411
	Emerald	53144412
Accessories		
Soda lime cylinder		3144420
Transport trolley	1010 x 510 x 1080 [L x B x H in mm]	5113893



ZL MULTIONE SERVICE TROLLEY

FOR AIR FLOW SYSTEMS

The ZL MultiOne service trolley is specially designed for the safe transport of gas cylinders. This means you can easily move the MultiOne to different locations.

Your benefits at a glance:

- The legal requirements for the stability and transport safety of gas cylinders are thus always complied with
- The additional drawer gives the user hands-free access to essential items such as documents and other items in the minimum amount of space.
- Even a fold-out table is always on the move, thanks to the integrated "tablet" in the drawer.
- The drawer can also be opened on both sides. This means that the additional table surface can also be folded out on both sides.

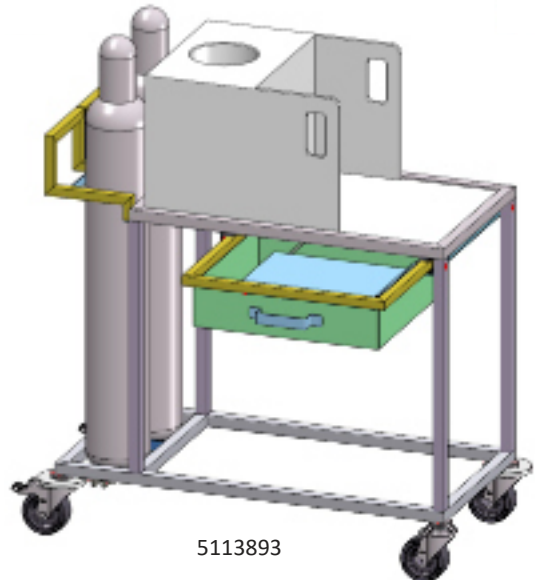

The MultiOne trolley is the ideal complement to MultiOne, making it suitable for mobile use with maximum freedom in any space.

Subject to technical modifications.

POLYCARBONATE ENRICHMENT FOR RODENTS

Our polycarbonate enrichment is ideally suited for scientific animal husbandry. Inside the polycarbonate enrichment, the animals feel protected and safe whilst also being clearly visible to the users.





POLYCARBONATE ENRICHMENT

FOR RODENTS



Mouse shelter

- Colour: Red transparent
- Autoclavable, non-toxic
- Stackable
- Provides a feeling of safety and protection
- Dimensions: 100x90x55 mm (L x W x H)
- Order no. 3084010



Mouse igloo with running plate

- Mouse-igloo plate: red-transparent
- Running plate colour: Amber
- Autoclavable, non-toxic
- The running plate promotes the instinctive running behaviour and increases activity
- The products can also be purchased individually.
- Mouse-igloo Order no. 3084011
- Running plate Order no. 3084012



Tunnel

- Material: Polycarbonate - 4 mm
- Autoclavable
- Promotes animal activity, reduces boredom and aggressive behaviour
- Mouse tunnel dimensions: 100 x Ø 50 mm
- Order no. 3084040
- Rat tunnel dimensions: 155 x Ø 75 mm
- Order no. 3084014



Crawl Ball

- Colour: Red transparent
- Autoclavable, non-toxic
- Provides the animal with a good opportunity to hide
- Order no. 3084042



Guinea pig house

- Colour: Red transparent
- Autoclavable, non-toxic
- Option to withdraw
- Dimensions: 205 x 157 x 115 mm (L x W x H)
- Order no. 3084051



Clip on handling tube

- Colour: transparent
- Teasy to fix on the lid
- Autoclavable, non-toxic
- Option to withdraw
- Length 110 mm
- Material: Polycarbonate
- 1 piece per Packing unit
- Order no. 3084193

POLYCARBONATE ENRICHMENT

FOR RODENTS



Tunnel Clip

- Easy to fix on the lid
- Autoclavable, non-toxic
- Material: Plastic
- 100 pieces / packing unit
- Order no. small 3084157
- Order no. large 3084159



Mouse tent

- Colour: Red- transparent
- Autoclavable, non-toxic
- Provides the animal with a good opportunity to hide
- Dimensions (L x W x H): 130 x 130 x 38 mm
- Material: Polycarbonate
- 1 piece / packing unit
- Order no. 3084086



Nombroero

- Colour: Red
- Easy to fix on the lid
- Autoclavable, non-toxic
- For placing food
- Material: Polycarbonate
- 1 piece / packing unit
- Order no. 3084137



C-Saw

- For Occupation
- Autoclavable, non-toxic
- offers protection and promotes activity
- Dimensions: (L x W x H)
- Material: Polycarbonate
- 1 piece / packing unit
- Order no. 3084195



Clear Handling Tubes

Grabbing mice by the tail should always be avoided. The use of handling tubes makes the transfer of mice stress-free for people and animals.

- Autoclavable, non-toxic
- Reusable
- Mice quickly get used to the tunnels
- Material: Polycarbonate
- 1 piece / packing unit
- Order no. 100 mm length 3084104
- Order no. 130 mm length 3084094



POLYCARBONATE ENRICHMENT

FOR RODENTS



Mouse Mezzanine

- Developed by users
- Autoclavable, non-toxic
- Reusable
- Material: Polycarbonate
- 1 piece / packing unit
- Order no. 3084130



Rodent Retreat

- Autoclavable, non-toxic
- Reusable
- Offers protection and promotes activity
- Colour: red and blue
- Dimensions (L x W x H): 95 x 95 x 152.5 mm
- Material: Polycarbonate
- 1 piece / packing unit
- Order no. red: 3084063
- Order no. blue: 3084219

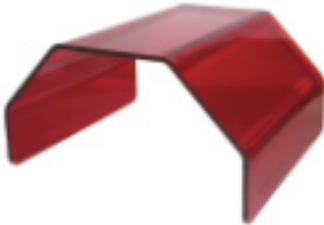

Fat Rat Hut

- Autoclavable, non-toxic
- Reusable
- offers protection and promotes activity
- Dimensions (L x W x H): 150 x 165 x 85 mm
- Material: Polycarbonate
- 1 piece / packing unit
- Order no. red: 3084059

ENRICHMENT

FROM RENEWABLE RAW MATERIALS

Our bedding and nesting materials have grown over many years. Today we have a wide selection of bedding, nesting and activity materials which enables the user to make the right choice for their needs. Our premium bedding and nesting materials form the basis for the well-being of the animals. All of the bedding and nesting materials from our range have been selected with the utmost of care to ensure their suitability for scientific animal husbandry, especially where strict GLP standards need to be adhered to.





HOUSES AND BRICKS

FROM RENEWABLE RAW MATERIALS



Smart-House for mice

- Provide excellent "enrichment"
- Manufactured from specially selected GLP-compliant pulp (analysis report will be made available on request)
- Autoclavable
- Ideal for IVC's



Corner house for rats

Smart-House for mice, 2-part

- Size: 130x 90 mm, 60 mm high – ~ 500 pcs/box
- Order no. 3084018

Corner-House for rats

- Size: 210x 210mm, 100 mm high – ~ 200 pcs/box
- Order no. 3084016

ASPENBRICKS



Aspenbricks

- Satisfy the natural gnawing, hiding and climbing instincts
- Reusable following cage change
- Batch-coded with full traceability
- GLP-compliant
- Autoclavable or can be supplied irradiated

Aspenbricks (M)

- Size: 10 x 2 x 2 cm – ~ 200 pcs/box
- Order no. 3084035

Aspenbricks (S)

- Size: 5 x 1 x 1 cm – ~ 2.000 pcs/box
- Order no. 3084034

NESTLETS



Nestlets

Nestlets take advantage of the innate instinct of rodents to tear up everything they find and build nests with it. The perfect nesting material for mice, hamster, gerbils and rats

- Nestlets are clean, dust-free and easy to handle
- autoclavable
- made of crushed cotton fibres, sterilised during manufacture and packaged cleanly
- Sufficiently pathogen-free for any application
- Long shelf life
- Packaged in extra-strong PE bags
- Shipped in dust-proof, sturdy cardboard boxes
- Box content: 100 sheets 30 x 30 cm, pre-punched to allow easy dividing into 3,600 Nestlets (5 x 5 cm).
- Order no. 3097055

NESTING AND ACTIVITY MATERIALS

FROM RENEWABLE RAW MATERIALS

Nesting materials for mice and rats are clean and free from dust (IVC suitable), easy to handle and autoclavable.



Enrich-n`Nest

Enrich-n`Nest

- White, clean paper rolls
- Promotes animal activity
- Fully biodegradable
- Suitable for hairless mice
- Packaging unit: 35 L / bag (approx. 7 kg)
- Order no. 3084007



Cocoon

Cocoon

- Small, white cylindrical fibres
- Made from natural materials without chlorine
- Easy for the animals to dismantle
- Promotes animal satisfaction
- Size: 36 x 12 mm
- Packaging unit: Box each containing ~ 6.000 pcs
- Order no. 3084008



AspenWood Wool

AspenWood Wool

- Soft wood strips.
- Ideally suited for nest-building
- Suitable for adult mice and rats
- Size: 1.5 x 20 mm
- Packaging unit: 90 L / bag (approx. 3 kg)
- Order no. 3084005



Paper Shavings

Paper Shavings

- White, soft paper shavings.
- Clean and absorbent.
- Suitable for small animals.
- Autoclavable
- Packaging unit: ~ 10 kg / bag
- Order no. 3084004

Pure-o`cel



Pure-o`cel

- White, clean paper chips for maximum absorption
- Virtually dust free, fully biodegradable
- Particle size: 4 x 4 mm
- Packaging unit: 24 L / box
- Order no. 3084006



NESTING AND ACTIVITY MATERIALS

FROM RENEWABLE RAW MATERIALS



CellPad

CellPad

- Occupation and nest building
- Easy to fix on the lid
- Size: 100 x 50 mm
- Packaging unit: 1500 pcs. / box (approx. 7 kg)
- Order no. 3084141



Paper Wool

Paper Wool

- Encourages animals to forage
- Serves as nest building material
- Promotes the satisfaction of the animal
- Packaging unit: ~ 10 kg
- Order no. 3084003

NESTING AND ACTIVITY MATERIALS

FROM RENEWABLE RAW MATERIALS



Nestpaks

Nestpaks

Nestpaks are a unique combination of bedding material and quality paper bags. Animals become occupied by tearing up the paper bags, building nests and spreading the bedding material.

- Nestpaks reduce workload
- Nestpaks are accurately proportioned by the specified bag size
- Certificates of analysis are available
- Nestpaks are autoclavable and ideal for IVC-housing

Description	Order no.
„Aspen“ Nestpak 100 g – 200 pcs. per box	3084020
„Grade 6“ Nestpak 100 g – 200 pcs. per box	3084024
„Grade 6“ Nestpak 200 g – 100 pcs. per box	3084037

Nestpaks are only available on palletts (12 boxes per pallet)



Play tunnel

Play tunnel

- Manufactured from brown paper
- The play tunnels are tested and analysed for harmful substances
- Certificates of analysis are available

Description	Order no.
Play tunnel 75 x 38 mm – ~ 800 pcs. per box	3084030
Play tunnel 125 x 90 mm – 80 pcs. per box	3084031
Play tunnel 250 x 101 mm – 48 pcs. per box	3084032
Play tunnel 100 x 50 mm – ~ 400 pcs. per box	3084033



Sizzle Nest

Sizzle Nest

- Premium, dust-free nesting material
- Ideally suited for a comfortable sub-surface
- Good absorption properties
- IVC-suitable
- Autoclavable

Description	Order no.
Sizzle Nest, ~ 10 kg / box	3084001



Bed-R'-Nest

Bed-R'-Nest

- reduces stress level
- Nest building material
- Minimises dust during cage change
- Autoclavable

Beschreibung	Bestell-Nr.
Bed-R'-Nest, ~ 800 pcs. per box	3084069



ECO - BEDDING

SUSTAINABLE

The sustainable alternative for bedding

suitable for mice and rats, clean and free of dust (IVC suitable), easy to handle and autoclavable



ECOBED F3

EcoBed F3

- Made from spruce wood
- Particle size 2 - 4 mm

Description	Order no.
EcoBed F3, 10 kg / box	3084207



ECOBED P3

EcoBed P3

- Made from poplar wood
- Particle size 2 - 4 mm

Description	Order no.
EcoBed P3, 10 kg / box	on request



WOODSHAVING

Woodshaving

- Made from soft wood
- Particle size 2 - 30 mm

Description	Order no.
Woodshaving, 4 kg / bag	3084209

ECO - GNAWING WOOD



ECOBALLS

EcoBalls

- Made from beech
- Diameter 30 mm

Description	Order no.
EcoBalls, ~ 1000 pcs. / packaging unit	3084258



ECOWOOD STICKS

EcoWood Sticks

- Made from beech
- 10 x 50 mm or 20 x 100 mm
- 3400 pcs./ box

Description	Order no.
EcoWood Stick 10 x 50 mm, ~ 3400 pcs. / box	3084234
EcoWood Stick 20 x 100 mm, ~ 3400 pcs. / box	3084235



ECOASPEN BALLS

Aspen Balls

- Made from poplar wood
- Diameter 30 mm

Description	Order no.
AspenBalls, Packaging unit ~ 500 pcs.	3084158

ECO-HOMES

FROM RENEWABLE RAW MATERIALS

A new product with regard to improving the housing conditions of mice and a further contribution to 3R. Our organic mouse house is made of 100% renewable raw materials, is 100% compostable and stands for a conscious and careful use of our earth's resources.

It meets the strict standard of the European Union EN 13432 and the American standard ASTM D6400. The material leaves no questionable residues when composted and is therefore very environmentally friendly. The special manufacturing process brings the sugar cane fibres into a durable and stable shape.

The round shape of the organic mouse house can have an aggression-inhibiting effect.

ECOHOMES



- Made from 100 % sugar cane fibres
- Autoclavable
- Easy to use and dispose of
- Volume 250 ml
- Protects and insulates
- Food safe according to EN 13432
- 1,000 pieces per carton
- Ø 115 mm, height 45 mm, hole Ø 30 mm
- 2 inlets

Description	Order no.
EcoHomes ~ 1000 pcs. /box	3084218

HANDLING

THE SIMPLE ALTERNATIVE

SCRUFFGUARD



The ScruffGuard enables the gentle treatment of small animals while protecting the user from bites or needlestick injuries. A ScruffGuard can be used for subcutaneous, intraperitoneal and intramuscular administration of substances. It is also useful for subcutaneous implantation of microchips for identification purposes.

It is a good aid for trainees who are learning to handle small animals for the first time. ScruffGuards are available in disposable and reusable versions. ScruffGuards for single use are currently only available in size 9, which is suitable for adult mice (20-38 g). Sizes 6 to 10 are available as part of the reusable range.

Type	Material	Mouse weight	Order no.
ScruffGuard – Size 6	Nylon	< 14 g	3084236
ScruffGuard – Size 7	Nylon	< 14 g	3084261
ScruffGuard – Size 8	Nylon	14 - 20 g	3084259
ScruffGuard – Size 9	Nylon	20 - 38 g	3084213
ScruffGuard – Size 10	Nylon	25 - 46 g	3084262
ScruffGuard	Paper	20 - 38 g	3084217

THERMACAGE



Mini

The Mini Thermacage is a high quality warming cabinet designed for use in animal housing where space is limited. Its precise temperature control, simple 3-step instructions and easy access to the animals make it the perfect solution for post-operative care and blood sampling.

The standard size Thermacage is also available for larger rodents. With similar specifications to the Mini, it offers more space in the recovery areas.

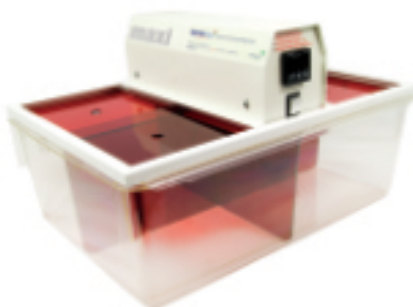

Standard

Type	Dimensions (W x D x H) in mm	Order no.
Mini	320 x 400 x 300	3085109
Standard	615 x 435 x 220	3085110



HANDLING

THE SIMPLE ALTERNATIVE

NSET- NON SURGICAL EMBRYO TRANSFER



For mouse line rehabilitation, the NSet is an ideal tool for successful embryo transfers. The NSet enables the non-surgical transfer of blastocyst stage embryos into the uterine horn of the female recipient. The efficiency of this non-surgical embryo transfer is similar to that after a surgical transfer. The method can also be used for reactivation of mouse strains.

Type	Order no.
NSet Embryotransfer 10 pcs. / Packaging unit	3084095

LABSAND



LabSand is a revolutionary patented hydrophobic sand. It greatly simplifies the collection of metabolically relevant urine samples from animals in laboratories and research facilities. LabSand retains urine on the surface and facilitates sample collection. The natural hydrophobic coating is non-toxic, sterile and biodegradable.

LabSand is laboratory validated and veterinary approved and has undergone extensive research and validation testing to ensure it does not alter any parameters of the urine sample obtained.

Non-invasive, stress-free and easy to use, LabSand is the solution for urine analysis in laboratories and research facilities.

Type	Order no.
3 pcs. (each 300 g) / box	3084091

ENRICHMENT

OCCUPATION FOR LARGER ANIMALS

Our polycarbonate enrichment is ideal for scientific animal housing. The material is tough, autoclavable and can withstand the forces of larger animals. Foraging games in particular keep animals busy and give them a sense of achievement.





FEEDING GAME – ENRICHMENT

FOR LARGE ANIMALS



Feed me

- For occupation
- Can be filled with dry food
- Autoclavable up to 134°C
- Non toxic
- Also suitable for large animals such as pigs, sheep or horses, dogs, cats or rabbits
- Dimensions (L x W x H): 270 x 110 x 110 mm
- Material: Polycarbonate
- 1 piece / Packing unit
- Order no. 3084300

ZOONLAB developed a posture for mounting on enclosure parts

A bracket has been developed to allow the feed roller to be installed in a fixed position on enclosure systems.

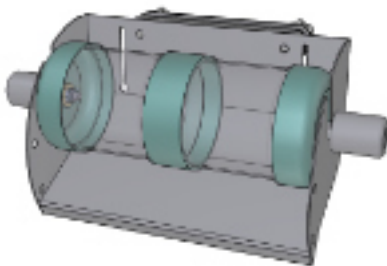

Feed me with bracket

- For occupation
- Can be filled with dry food
- Autoclavable up to 134°C
- Non toxic
- Also suitable for large animals such as pigs and sheep or horses
- Material of the bracket: stainless steel
- 1 piece / Packing unit
- Order no. on request

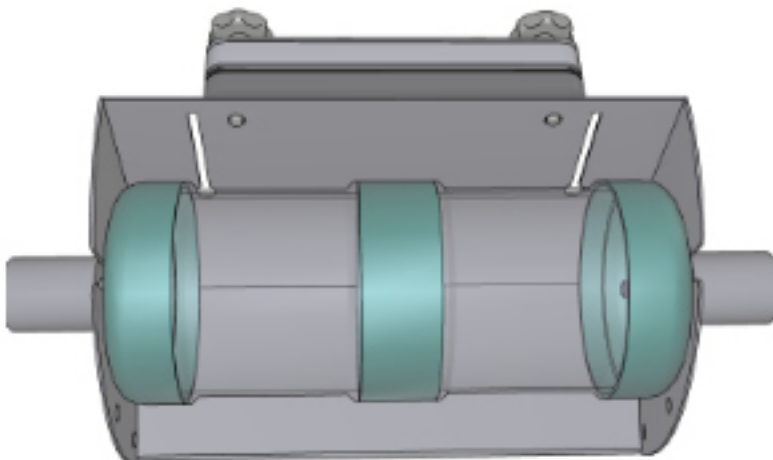

STAINLESS STEEL ENRICHMENT FOR RODENTS

Our stainless steel enrichment is ideally suited for scientific animal housing.

This sustainable alternative is readily accepted by the animals. Cleaning, washing and sterilisation processes have almost no impact on product life.

A clean, sustainable alternative to our plastic enrichment range.

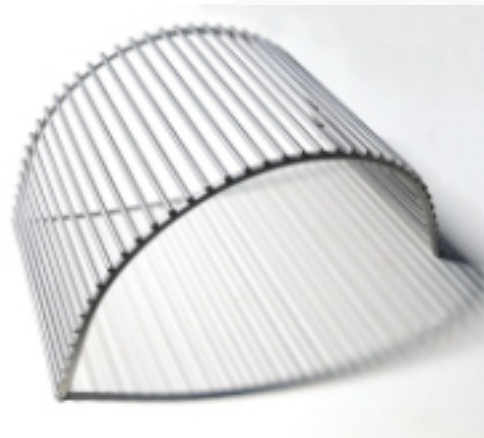
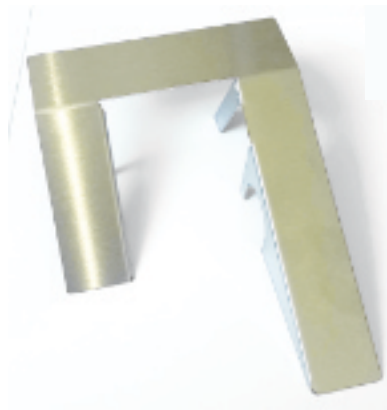



STAINLESS STEEL – ENRICHMENT

FOR RODENTS

MOUSE AND RAT ARCHES

stainless steel AISI 304

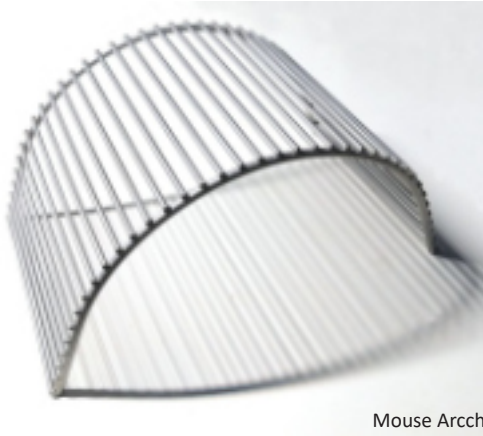

Mouse arches reduce aggression between animals and allow them to exercise their need to climb.

The round shape of the arches has been proven in scientific studies and is readily accepted by the animals. Natural behaviour is encouraged.

Type	Dimensions (L x W x H) in mm	Order no.
small	142 x 90 x 60	5083804
medium	160 x 95 x 70	5083801
large	166 x 90 x 94	5083805

MOUSE RAMP

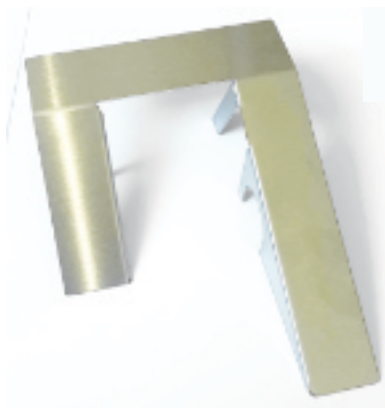

The stainless steel mouse ramp can be inserted into cages as an enrichment. The ramp can ensure accessibility to food and water for animals. Additionally, it serves as a basement enrichment that encourages exploration.

Type	Order no.
For cages Type 2 L	5084130

STAINLESS STEEL – ENRICHMENT

FOR RODENTS

MOUSE-CLIMBER

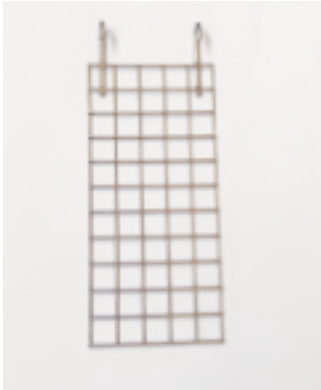

Mouse Climber is easy to fix on the lid of the cage and creates another climbing possibility for the animals. This makes it easier for the animals to reach otherwise inaccessible places.

Type	Dimensions (L x W x H) in mm	Order no.
Mouse-Climber	142 x 70	5063299



First-class enclosure systems

concept – design – construction – production – installation



The first choice for decades

ZOONLAB offers individual solutions for more than 70 years

The complete view of an enclosure system is the basis for a high-quality primate husbandry. Detailed spatial plans and installation drawings in 2D and 3D which we create in close cooperation with our customers are parts of our design & planning process.

In addition to capacity and structure we also focus on operation safety, daily routine working processes (for example feeding, cleaning, etc.) and individual type-specific habitat design (ENVIRONMENTAL ENRICHMENT) to provide optimal husbandry conditions.

Our team of experienced engineering draftsmen converts the concepts into technical construction drawings. Every element and every component is constructed in detail (CAD) and inspected for accuracy. After our customer's approval we start the production process.

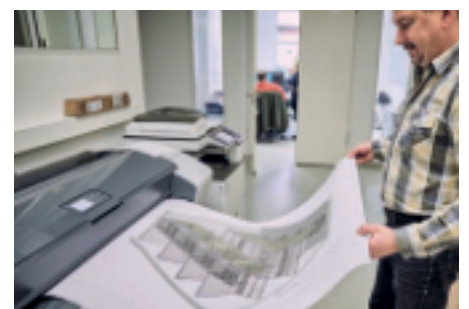
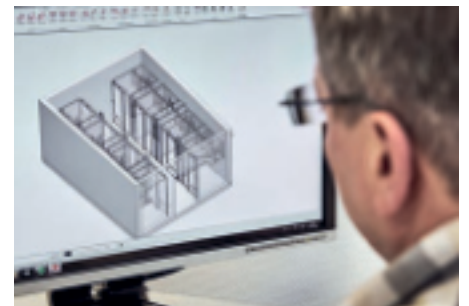



Fig. high demands on the quality and design of our animal welfare enclosure systems in detail



Fig. spatial plans and installation drawings in 3D of a primate husbandry system

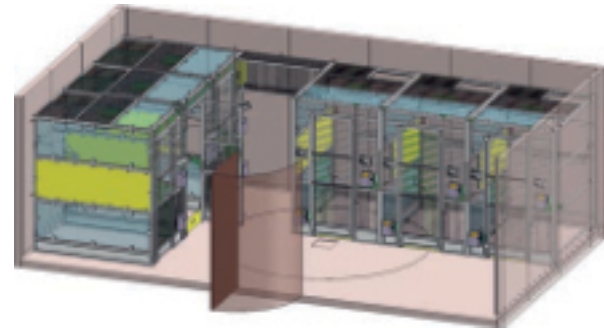
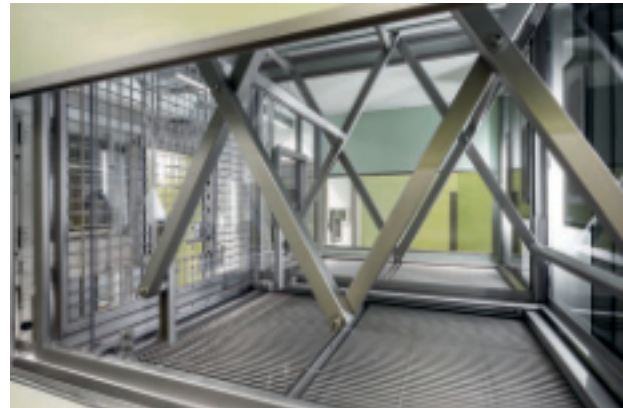

Fig. individual solutions by long-term experience



The husbandry of non-human primates (NHP) requires high standards in quality and design of animal welfare enclosure systems. ZOONLAB offers competent assistance and long-lasting quality starting from the first idea to the professional installation.

In addition to the proficient support during the whole project our service includes the conception, design and construction (CAD) of your new husbandry system such as the production at our own premises in Germany. The ZOONLAB installation team will complete the project at your facilities.

Decades of experience in building enclosure systems guarantee a wide experience in individual solutions and high-quality processing of stainless steel, safety glass and plastic materials – made in Germany.



Quality in every detail – Made in Germany

ZOONLAB proves itself through extraordinary ideas and excellent manufacturing

At our in-house production facilities our team professionally processes components of stainless steel, laminated safety glass and plastics, which are mainly used in the medical sector. Stainless steel components are manually welded using TIG welding to guarantee clean and corrosion resistant weld seams.

Afterwards all steel surfaces are finished by glass bead blasting. This provides homogeneous surfaces, enhanced optics and improved resistance against physical and chemical strain.



Fig. assembly production of stain-less steel components (TIG welding)

Fig. hygiene requirements – edges to prevent dirt accumulation



Fig. primate-safe cage closures



Fig. clean and corrosion resistant weld seams (TIG welding)



All ZOONLAB enclosure systems are planned, constructed and manufactured according to regulatory requirements (currently guideline 2010/63/EU of the European Parliament).

In addition the professional processing of selected high-grade materials, the implementation of colours and the innovative solutions for habitat designs create ideal conditions for the well-being of your animals.



During the conception, the construction and the production we always ensure hygiene (clean- liness of the enclosure systems) and safety for your animals (eg. no sharp edges, clean weld seams).

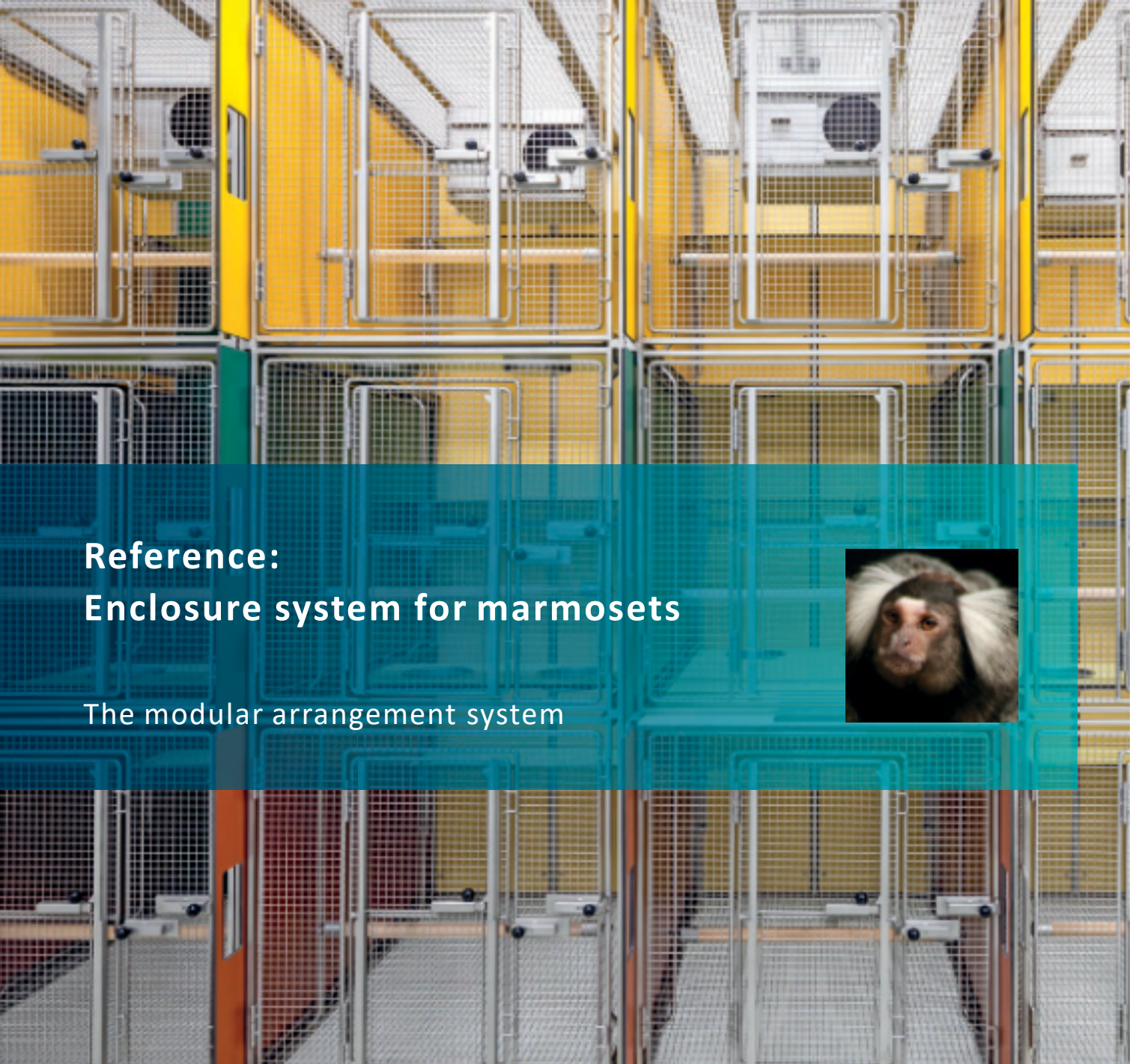

Reference: Enclosure system for marmosets

The modular arrangement system

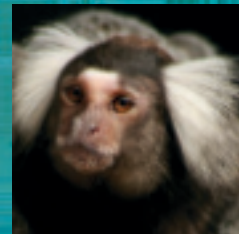

Fig. the application of colours in a husbandry system increases the well-being of the animals and is just one example of our innovative solutions.

Enclosure systems for housing marmosets usually consist of several single cage modules which are mounted together and can be modified into larger units with very little effort.

A single cage module (minimum floor area 0.5 m², minimum habitat height 1.5 m) is built of stainless steel and high-pressure laminate panels and is designed to house six adult animals in three compartments with removable floor panels.

The various colour options for the side and back panels allow for an individual interior design and an interesting environment for the primates.

ZOONLAB designs and produces your husbandry system according to your wishes and the welfare of the animals.



Fig. Professional processing of high-grade materials, suitable for scientific animal husbandries



Abb. All resting areas are adjustable in three positions and can be equipped with feeding bowls



Reference: Enclosure system for macaques and guenons

Life inside and outside of social groups



Fig. spacious group cages



Fig. individual interior
equipment



Fig. mobile capturing/
application cage for the
transport of single
animals

For the husbandry of macaques and guenons single cages with a floor area of 2 m² and a minimum habitat height of 1.8 m are needed.

ZOONLAB reviews the structural situation and designs suitable primate welfare habitats (in compliance with norm 2010/63/EU).

A high variety of designs and dimensions highlight the professional realization of resting areas, window panels, climbing and sitting areas according to the current requirements.

Tunnels or openings to adjacent cages create an enlargement of the habitation area.

This allows a life in social groups in smaller enclosure systems.

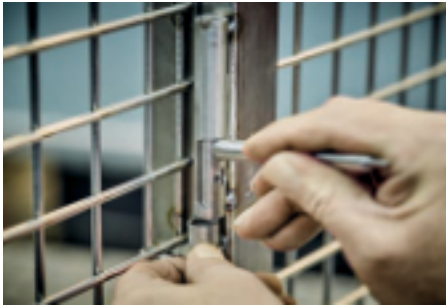

ZOONLAB GmbH
Animal Husbandry Experts
Branch office Hermannstraße 6 | 44579 Castrop-Rauxel | Germany
info@zoonlab.de | www.zoonlab.de

PRIMATE CAGES AND ENCLOSURES

ENCLOSURE SYSTEMS



Zoonlab primate cages are designed, engineered and manufactured according to our customer's specific needs and in line with the respective statutory requirements as per Directive 2010/63/EU of the European Parliament (formerly ETS 123).



INNOVATION IS OUR TRADITION

Our key driver is our commitment to find the ideal solution for any customer and our uncompromising willingness to innovate. Due to our market-oriented products combined with outstanding product quality and extensive service we have shown continued growth for many years. This is mirrored in our existing customer relationships.

Our sophisticated, animal-friendly enclosure systems are fitted with optionally available features such as resting zones, balconies, viewing windows and other enrichment. Design and colour of the facilities can be selected according to your preference. We use high-grade materials which are easy to decontaminate.

In light of our broad experience gathered in numerous comprehensive projects we offer our customers a wide range of solutions for any application.

- Our in-house CAD engineering converts the requirements in 3D models.
- All elements are laid out to safely accommodate the animal considering all aspects of animal husbandry and easy handling for users.
- This means maximum operational reliability.
- All parts have been designed to be easily cleaned by hand or machine, including autoclaving processes.



Large enclosure for dogs or cats

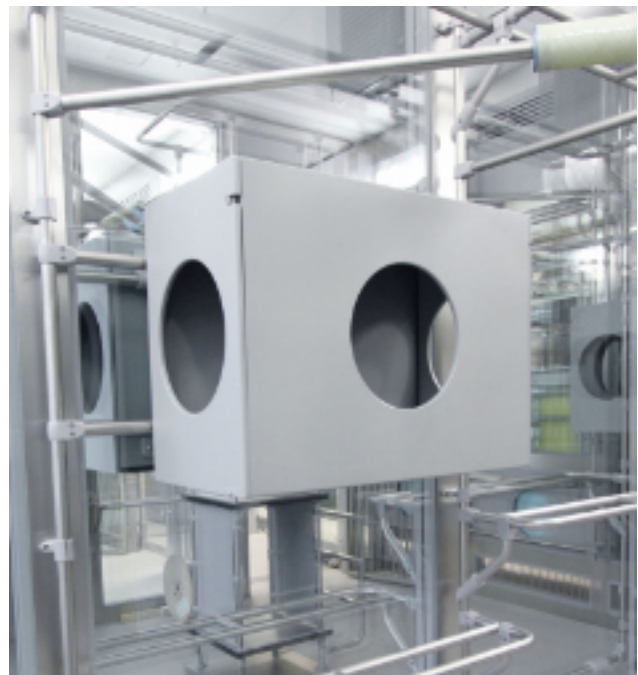

Primate cage with resting zone



Primate cages fitted with balconies



Custom-made product as per specific requirement

TRANSPORT AND AUTOCLAVING TROLLEYS

TRANSPORT & ACCESSORIES

All trolleys are made of stainless steel and are equipped with 4 castors with a diameter of 100 mm (2 of them with brakes). The castors are equipped with a stainless steel housing and are autoclavable up to max. 134°C.

Our castors have a high quality Teflon coating and are extremely durable. The tread allows smooth running with low wear and long life. The trolley is fully autoclavable at 134°C. The height of the shelves can be adjusted.





TRANSPORT AND AUTOCLAVING TROLLEYS

CLOSED TROLLEY

The transport and autoclaving trolley has two lockable doors, recessed grips on both sides and is equipped with EU 4 filter mats on the back. Our trolleys are equipped with high-quality and autoclavable castors (article 5113814).

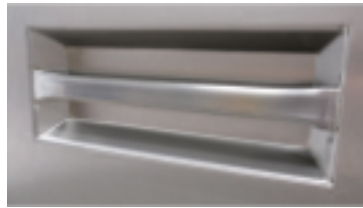

recessed grips on both sides



Shell handle

Type	Dimensions (W x D x H) in mm	Material	Order no.
T-A (1.500 mm H) closed	990 x 512 x 1.520	Stainless steel AISI 304	5113760
T-A (1.900 mm H) closed	990 x 512 x 1.910	Stainless steel AISI 304	5113761
Options			
Additional shelf		Stainless steel AISI 304	5420002

TRANSPORT TROLLEY TWA



TWA9/5/18-LB

Type	Dimensions (W x D x H) in mm	Material	Order no.
TWA 9/5/18-LB	966 x 566 x 1.770	Stainless steel AISI 304	5113698
TWA 12/5/18-LB	1.206 x 500 x 1.770	Stainless steel AISI 304	5113775
TWA 9/5/18-GB	967 x 507 x 1.800	Stainless steel AISI 304	5113776
TWA 12/5/18-GB	1.206 x 507 x 1.770	Stainless steel AISI 304	5113777
TWA 9/5/18-DB	960 x 500 x 1.770	Stainless steel AISI 304	5113778
TWA 12/5/18-DB	1.200 x 500 x 1.770	Stainless steel AISI 304	5113779

The distance between the shelves is 590 mm.

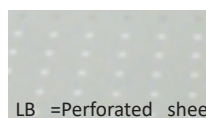

LB = Perforated sheet

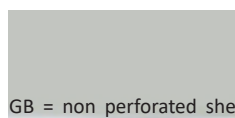

GB = non perforated sheet



DB = spot-welded wire grid

TRANSPORT AND AUTOCLAVING TROLLEYS

OPEN TROLLEY



Transport and autoclaving trolley with 3 rear inclined, perforated and high-sided shelves - shelf distance 605 mm. Our trolleys are fitted with high quality autoclavable castors (article 5113814).



Type	Dimensions (W x D x H) in mm	Material	Order no.
TWA-1000	1000 x 500 x 1.858	Stainless steel AISI 304	5113814
TWA 1250	1.250 x 500 x 1.858	Stainless steel AISI 304	5113813
TWA 1500	1500 x 500 x 1.858	Stainless steel AISI 304	5113834

TRANSPORT-/PLATTFORM TROLLEY



TW 4921-91S

Type	Characteristics	Dimensions (W x D x H) in mm	Material	Order no.
TW 4921-91S	Loading area without sliding edge	940 x 500 x 920	Stainless steel AISI 304	5113750
TW 4922-91S	Loading area without sliding edge	1.100 x 700 x 920	Stainless steel AISI 304	5113751
TW 4931-91S	Loading area with sliding edge	945 x 500 x 920 With handle: 1044 x 500 x 920	Stainless steel AISI 304	5113748
Options				
Anti-noise mat	Supporting surfaces equipped with an anti-rattle mat. This prevents the goods from rattling during transport.			On request



TRANSPORT TROLLEY

2-SELVES

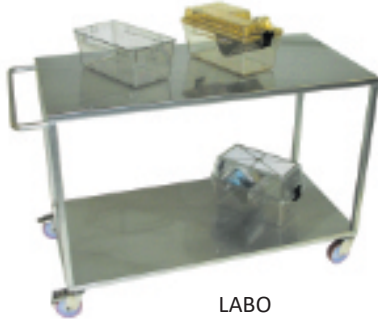

LABO



ABSA

The upper shelf is equipped with a waste opening with clamping ring on one side in order to fasten a conventional waste bag.

Type	Dimensions (W x D x H) in mm	Material	Order no.
LABO	1.200 x 575 x 830 Shelf distance 653 mm	Stainless steel AISI 304	5113702
ABSA	1.200 x 604 x 1.020 Shelf distance 862 mm	Stainless steel AISI 304	5113707

TRANSPORT TROLLEY TW-MSW



TW-MSW 8 x 5 / 2

Type	Characteristics	Dimensions (W x D x H) in mm	Material	Order no.
TW-MSW 6 x 4/2	autoclavable	695 x 495 x 900, 2 levels	Stainless steel AISI 304	5111735S
TW-MSW 8 x 5/2	autoclavable	895 x 595 x 950, 2 levels	Stainless steel AISI 304	5111736S
TW-MSW 10 x 6/2	autoclavable	1.095 x 695 x 950, 2 levels	Stainless steel AISI 304	5111738S
TW-MSW 6 x 4/3	autoclavable	695 x 495x 900, 3 levels	Stainless steel AISI 304	5111732S
TW-MSW 8 x 5/3	autoclavable	895 x 595 x 950, 3 levels	Stainless steel AISI 304	5111733S
TW-MSW 10 x 6/3	autoclavable	1.100 x 700 x 960, 3 levels	Stainless steel AISI 304	5111734S
Options				
Anti-noise mat	Supporting surfaces equipped with an anti-rattle mat. This prevents the goods from rattling during transport.			On request

STORAGE CONTAINERS

MOBILE

With lid suspension function on the container for easier, ergonomic working. For the safe storage and transport of a variety of goods. Autoclavable and rodent-proof. Fitted with smooth-running castors. Fully autoclavable.



FVB 2

Height with handle 916 mm
 Total height to lid 851 mm
 Total width with handle 744 mm
 Container dimensions (L x B) 546 x 546 mm

FVB 3

Total height to lid 1038 mm
 Total width 630 mm without deflectors



FVB 2 L

Height with handle 916 mm
 Total height to lid 886 mm
 Total width with handle 1320 mm

Type	Volume in Litre	Dimensions (W x D x H) in mm	Material	Order no.
FVB 2	97	500 x 500 x 845	Stainless steel AISI 304	5113724
FVB 2 L	194	1.300 x 581 x 880	Stainless steel AISI 304	5113726
FVB 3	473	1.000 x 600 x 800	Stainless steel AISI 304	5113725
Options				
Perforated sheet			Stainless steel AISI 304	2309036
Card holder			Stainless steel AISI 304	2302213

AUTOCLAVING TROLLEY

FOR FEED SACKS

Manoeuvrable transport and autoclaving trolley for feed sacks of approx. 12 kg. Made of stainless steel AISI 304 with movable holders for optimal positioning of the feed sacks. The minimal contact surface of the holders ensures optimum autoclaving results and avoids feed clumping.

Typ	Dimensions (W x D x H) in mm	Order no..
Autoclaving trolley for feed sacks	1.000 x 500 x 1.333	5033548





TRANSPORT SYSTEM FOR CAGES

TRANSPORT TROLLEY FOR CAGES

The ZOONLAB transport system for cages makes logistics and storage easier and faster in day-to-day operation. Round tubes and autoclavable easy-running castors ensure excellent transport comfort.

The trolley can also be used in the same way as a sack truck. The trolley made of stainless steel is glass-bead blasted and autoclavable. Two of the four castors can be steered and locked into place. (Two of the castors cannot be steered so that the trolley can be used as a sack truck). We can also optionally produce trolleys for all conventional cages on the market, including for cages produced by other manufacturers.



Trolley for cages Typ 1 L, 2 und 2 L

Description	Material	Dimensions (W x D x H) in mm	Order no.
Trolley for cage types 1L, 2 and 2L, 2 rows on top of each other, 2 rows next to each other, capacity: 40 cages	Stainless steel AISI 304	507 x 441 x 1.372 507 x 546* x 1372	5113757
Trolley for cage type 4, 2 rows on top of each other, capacity: 16 cages	Stainless steel AISI 304	631 x 440 x 1.372 736* x 440 x 1372	5113758
Options			
Cover hood for trolley (cage types 1L, 2, 2L) white fabric, 2 strong zips in the corners, can be sterilised in 5 minutes at 136 degrees	Canvas fabric, white	507 x 454 x 1.250	3119948
Cover hood for trolley (cage type 4) white fabric, 2 strong zips in the corners, can be sterilised in 5 minutes at 136 degrees	Canvas fabric, white	735 x 440 x 1.250	3119949

* Dimensions with handle

TRANSPORT SYSTEM FOR WATER BOTTLES

TRANSPORT TROLLEY FOR BOTTLE WASHING BASKETS

The ZOONLAB transport system for bottle washing baskets makes all of the work processes associated with drinking bottles easier on a day to day basis. The transport trolley and the matching washing basket ensure an ergonomic and efficient water bottle management.



ZOONLAB transport trolleys for washing baskets make the day-to-day work with water bottles easier. The loaded washing baskets remain in the transport trolley for the entire procedure during the loading and unloading process. Plastic rails (option) simplify the removal of the baskets and prevent bothersome grinding noises. Round tubes and autoclavable easy-running castors ensure excellent transport comfort. The rack made of stainless steel is glass-bead blasted and autoclavable. The front castors can be locked so that the user is able to switch between precise mobility and a firm standing. The standard model provides capacity for 10 bottle washing baskets but transport trolleys for 12, 15 or 18 baskets can also be produced on request.

Type	Description	Dimensions (W x D x H) in mm	Order no.
TW-FSPÜ suitable for 10 bottle washing baskets - 5 on top of each other in 2 rows without polyamid guide rails	for bottle washing baskets up to 270 mm high	610 x 640 x 1.631	51137059
TW-FSPÜ-PA suitable for 10 bottle washing baskets - 5 on top of each other in 2 rows with polyamid guide rails	for bottle washing baskets up to 270 mm high	610 x 640 x 1.631	51137058
Options			
TW Cover hood	5 minutes at 136 degrees sterilisable "saturated steam"	640 x 680 x 1.350	3119947

Our ZOONLAB bottle washing baskets:





BOTTLE WASHING BASKETS

MADE OF STAINLESS STEEL, STACKABLE

ZOONLAB bottle washing baskets enable more effective and easier cleaning of all conventional-sized water bottles. They are made of stainless steel, electrolytically polished and autoclavable. All of the washing baskets versions can be stacked on top of one another. The bottles are fixed into place via a detachable cover which also ensures that they remain secure during the cleaning process.

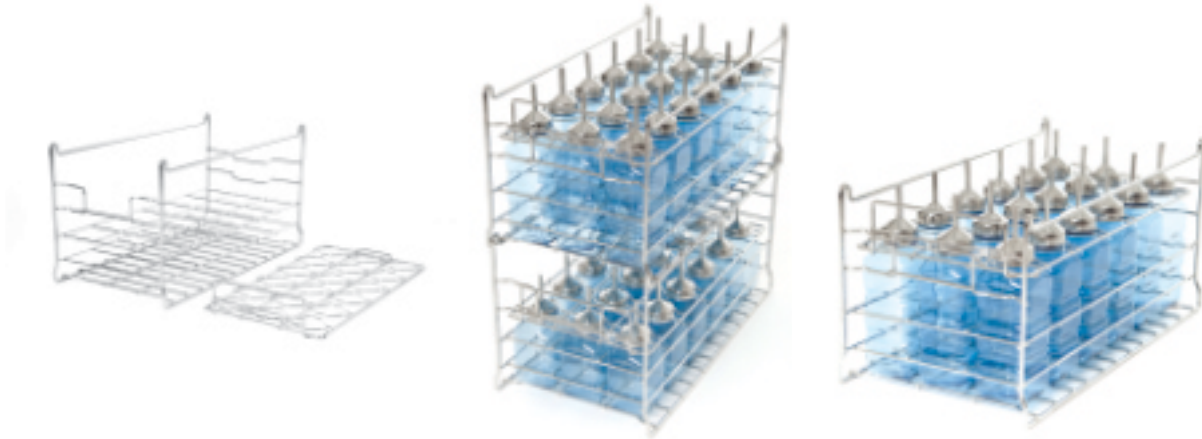

Type	No. of bottles / bottle types	Dimensions (W x D x H) in mm	Order no.
FSPÜ 25-30 / 250	18 / F 25 und F 30	500 x 265 x 250	5122099
FSPÜ 40-75 / 250	18 / F 53, F 40, F 75	500 x 265 x 250	5122100
FSPÜ 25-30 / 270	18 / F 25 und F 30	500 x 265 x 270	5122096
FSPÜ 40-75 / 270	18 / F 53, F 40, F 75	500 x 265 x 270	5122097
OPTIONS			
FSPÜ Cover	Suitable for FSPÜ 25-30 and FSPÜ 40-75	483 x 240 Handle 70 mm high	5122098

MOBILE VARIABLE RACK, GV

FOR CAGES, STOCKS AND MUCH MORE



In addition to the traditional types of racks, ZOONLAB also supplies a variable rack that can accommodate any type of cage.

It is characterised by 6 extremely stable shelves made of grid elements (the grid bars run in the sliding direction of the cage), which are also infinitely adjustable in height as required. This gives maximum freedom of use. The shelves can be loaded up to 250 kg.

The entire rack is made of AISI 304 stainless steel and is fitted with 4 swivel castors of 100 mm diameter, two of them with brakes. The castor housing is made of stainless steel. The frame and castors are fully autoclavable. A bowl holder can be added to the frame as an option.

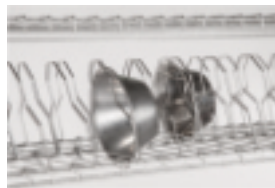

Bowl holder
Further options on request

Short description	Capacity per shelf	Dimensions in mm (W x D x H)	Order no.
GV - Rack for variable mounting of the cages (depth 582 mm)	6 cages Type 1 L 5 cages Type 2 (10 cages Typ 2 in 2 rows) 5 cages Type 2 L 4 cages Type 3 3 cages Type 4	1.236 x 582 x 1.763	5033520
Optional components			
GV-Holder for feeding bowls			5063398
Cover plate with elevation			5033551
Additional shelf made of grid elements	Loadable with 250 kg - Screwable - Retrofit module		4033200
Rack attachment with cover plate	screwable - retrofitting module	H 250	5033222
GV - Rack for variable mounting of the cages (depth 800 mm)		1.236 x 832 x 2.013	5033533
Optional components			
Cover plate with elevation			On request
Additional shelf made of grid elements	Loadable with 250 kg - Screwable - Retrofit module		On request



LECTERN

DOCUMENTATION TABLE



The ZOONLAB standing desk, made of stainless steel, can serve you as a lectern, documentation desk and storage, plus other applications in the animal husbandry sector.

The smooth-running castors also make it easy to move. Two of the four castors are lockable.

The ZOONLAB standing desk is autoclavable.

Type		Diemensions in mm (W x D x H)	Material	Order no.
Base frame with document compartment	autoclavable	650 x 470 x 1.100	Stainless steel	5115026
Option in combination with the base frame				
Printer compartment for lectern	autoclavable	591 x 447 x 300	Stainless steel	5115027
Drawer for lectern	autoclavable	532 x 326 x 150	Stainless steel	5115028
Extendable keyboard rack	autoclavable	531 x 300 x 20	Stainless steel	5115029
Inclined lectern rest for 12° inclination, applied loosely to the lectern	autoclavable	606 x 456 x 139	Stainless steel	5115024

Subject to technical modifications.